

# **MOXA IP Camera**

---

## **VPort P06HC-1MP-M12 Quick Installation Guide**

**First Edition, December 2013**



© 2013 Moxa Inc. All rights reserved.

**P/N: 1802000061010**

# Overview

The VPort P06HC-1MP-M12 series is a square, flush mount, HD (720P, 1280 x 720) video image, H.264/MJPEG IP camera designed for mobile video surveillance applications. It features EN 50155 compliance, a -25 to 55°C operating temperature, rugged M12 Ethernet port, 1 microphone, 1 digital input PoE power input, IP66 rain and dust protection, and selectable lens models, for the versatility and ruggedness required to excel in many different installations and environments for mobile IP video surveillance applications.



## Package Checklist

Moxa's VPort P06HC-1MP-M12 is shipped with the following items. If any of these items are missing or damaged, please contact your customer service representative for assistance.

### 1 x VPort P06HC-1MP-M12 (lens included)

Standard Temperature Models	Lens
VPort P06HC-1MP-M12-CAM36	3.6 mm

### Accessories Package

Torx screw driver for loosening the camera's front lens cover	Silica gel dessicant and hook fastener for absorbing the moisture inside the camera	2 L-type installation kits and 4 nylock screws for mounting the camera
		

### Sticker for Camera Mounting Positions

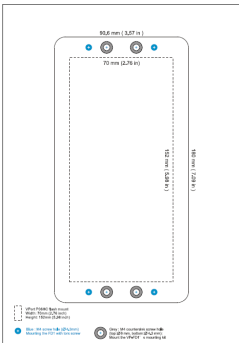

- Quick Installation Guide
- Documentation and Software CD (includes User's Manual, Quick Installation Guide, and VPort Utility)
- Warranty card

**NOTE** Check the model name on the VPort's side label to determine if the model name is correct for your order.

**NOTE** This product must be installed in compliance with your local laws and regulations.

## Features

- 1/2.7" HD progressive CMOS image sensor
- Video stream up to 30 frames/sec at WXGA (1280x800) resolution
- High image quality with WDR (wide dynamic range) and DNR (Digital Noise Reduction) supported
- Minimum illumination is up to 0.2 lux (color)
- Supports MJPEG and H.264 Dual Codecs
- Provides 3 video streams for H.264 and MJPEG simultaneously
- Supports video quality configuration with fixed bit rate (CBR) and fixed quality (VBR)
- Video latency under 200 ms
- DynaStream™ for network efficiency with dynamic frame rate change
- CBR Pro™ supported for high image quality in limited bandwidth transmissions
- WXGA/720P/SVGA/Full D1/4CIF/VGA/CIF/ QCIF resolution
- TCP, UDP, and HTTP network transmission modes
- Supports DHCP OPT66/67 for automatic configuration from a TFTP server, making it easy to batch configure several units
- Supports RTSP streaming
- Supports multicast (IGMP) video streaming
- Supports SNMP (V1/V2C/V3) for network system integration and management
- Supports QoS (ToS) for transmission priority
- Built-in web server for easy configuration
- Accessible IP filtering
- UPnP supported
- Compliant with EN 50121-3-2 and relevant sections of EN 50155 (compliant with IEC 60571)
- 1 10/100BaseT(X) port with M12 D-code connector
- 1 built-in microphone for audio input
- 1 digital input with 5-pin M12 connector for external events
- IP66 rain and dust protection
- PoE (Power-over-Ethernet, IEEE 802.3af) supported
- -25 to 55°C (EN 50155, class T1) operating temperature for rolling stock environments
- CE, FCC, UL 60950-1
- Built-in tamper alarm and Video Motion Detection (VMD)
- Pre, Trigger, and post snapshot images supported
- Sequential snapshot images supported
- Supports SMTP and FTP for alarm message transmission
- Supports HTTP event server
- 5-year warranty

# Product Description

## Appearance

Removable lens cover

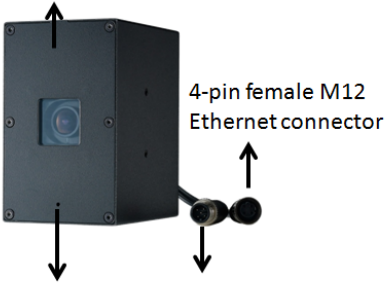





Built-in Microphone      5-pin male M12 connector for 1 digital input

- 4-pin female D-code M12 Ethernet connector:** Can be used for both the PoE power supply (Mode A) and Auto MDI/MDI-X Ethernet connection

PIN	TX
1	TD+
2	RD+
3	TD-
4	RD-



**NOTE** To connect the VPort P06HC-1MP-M12 to a network, use an Ethernet cable with D-code M12 connector and an M12 PoE switch or RJ45 PoE switch.

M12 male to M12 male cable 	M12 PoE Switch (e.g., TN-5508-4PoE) 
M12 male to RJ45 cable 	RJ45 PoE switch (e.g., EDS-P510) 

**NOTE** The power input rating of the VPort P06HC-1MP-M12 is 48 VDC, 0.13 A, with maximum power consumption approximately 6.3 W.

**NOTE** The equipment is designed for in building installation only and is not intended to be connected to exposed (outside a plant) networks

- **5-pin M12 male connector:** The VPort P06HC-1MP-M12 supports one digital input with 5-pin M12 male connector. This DI is used for connecting with external device for triggering an event or alarm.

• <b>Digital input</b>	Max. 8 mA, Low: +13 V to +30 V; High: -30 V to +3 V
------------------------	--



Configuration: 05 Pins  
System: Connector (M)  
Mating Cable : Socket (F)  
Code : A-polarization

Pin	Signal
1	I+
2	Not used
3	Ground
4	Not used
5	Not used

**NOTE** This digital input is for connecting with an external device, such as a button, for triggering an event and alarm. The VPort P06HC-1MP-M12 can send messages via an IP network to the management software at a remote site.

- **Built-in microphone:** The VPort P06HC-1MP-M12 is equipped with a built-in microphone to receive external sounds. The sound will be digitized and compressed as an audio stream for network transmission with the video stream.

**NOTE** The effective distance for the VPort P06HC-1MP-M12's built-in microphone is 100 cm.

- **Removable lens cover:** The VPort P06HC-1MP-M12 is designed with a removable cover for fine-tuning the lens angle manually. The user can remove this lens cover after loosening the 6 torx screws.

**NOTE** The VPort P06HC-1MP-M12's optical lens cover is coated with a high performance waterproof coating. Please use the scrubbing cloth to light clean the cover.

**NOTE** The color of the lens cover can be customized based on your installation environment. Please contact your Moxa sales representative for customization service.

**Inside the Camera**

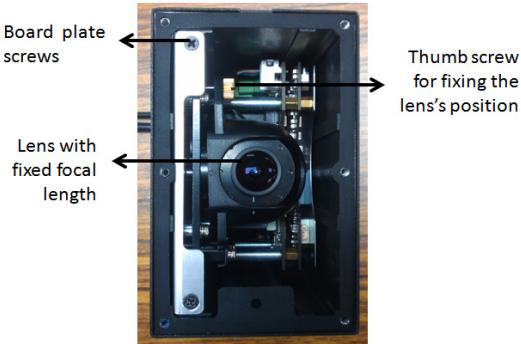

- **Thumb screw for fixing the lens's position:** To tune the lens's position, loosen the thumb screw, and then retighten it after the position tuning is done.
- **Lens with fixed focal length:** The VPort P06HC-1MP-M12 series supports a fixed focal-length lens. Choose the appropriate focal-length lens based on the viewing angle and object distance.
- **Board plate screws:** these 2 screws are for loosening the board plate, which can be pulled out for tuning the camera lens position.



**Hardware Installation**

**NOTE** To flush mount the VPort P06HC with an intercom, use the VP-FD1 accessory (must be ordered separately) to install the camera. If you do not want to use the VP-FD1, refer to the dimensions on the installation sticker for customizing your own installation.



← using the VP-FD1 for installing with an intercom

# VP-FD1

**Front decorative plate with 4 M4 screws**



**Mounting kit for fixing VPort P06HC and front decorative plate**

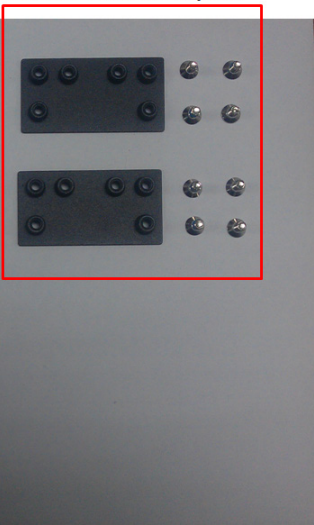

**Step 1:** Screw the 2 L-type installation plates onto the VPort P06HC.

Vertical mountable



Horizontal mountable



**Step 2:** Use the installation sticker to drill the holes for flush-mounting the VPort P06HC with the VP-FD1.

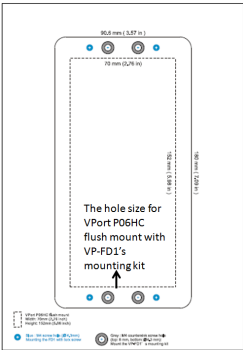

M4 countersink screw hole



**NOTE** The screw holes for mounting the 2 VP-FD1's mounting kits are countersunk holes with 8 mm top diameter and 4.3 mm chamfer. Take this into consideration when drilling these 4 screw holes.

**Step 3:** Install the VP-FD1's mounting kit.  
Screw 4 nylock M4 screws on the 4 countersunk screw holes with 2 VP-FD1's mounting kits.



Front view



Rear view



**Step 4:** Connect the VPort P06HC's connectors.





**Step 5:** Mount the VPort P06HC with the VP-FD1's mounting kit.



**Step 6:** Mount the VP-FD1's front decorative plate on the wall.



**NOTE** The type and color of VP-FD1 can be customized by request. Please contact a Moxa sales representative for this customization service.

# Software Installation

**Step 1:** Configure the VPort P06HC-1MP-M12's IP address.

When the VPort P06HC-1MP-M12 is first powered on, the POST (Power On Self Test) will run for a few moments (about 30 seconds). The network environment determines how the IP address is assigned.

## Network Environment with DHCP Server

For this network environment, the unit's IP address will be assigned by the network's DHCP server. Refer to the DHCP server's IP address table to determine the unit's assigned IP address. You may also use the Moxa VPort and EtherDevice Configurator Utility (edscfgui.exe), as described below:

## **Using the Moxa VPort and EtherDevice Configurator Utility (edscfgui.exe)**

1. Run the **edscfgui.exe** program to search for the VPort. After the utility's window opens, you may also click on the **Search** button  to initiate a search.
2. When the search has concluded, the Model Name, MAC address, IP address, serial port, and HTTP port of the VPort will be listed in the utility's window.

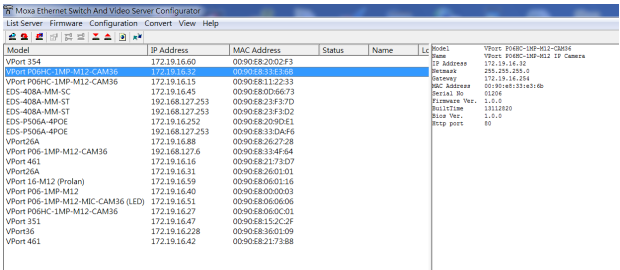

Model	IP Address	MAC Address	Status	Name	Lc	Model Name	VPort P06HC-1MP-M12-CAM36
VPort 354	172.19.16.60	0090E82002F3				IP Address	172.19.16.92
VPort P06HC-1MP-M12-CAM36	172.19.16.52	0090E833E368				Netmask	255.255.255.0
VPort P06HC-1MP-M12-CAM36	172.19.16.15	0090E8112233				Gateway	172.19.16.254
EDS-408A-MM-5C	172.19.16.45	0090E80D6673				MAC Address	0090E8131a21b
EDS-408A-MM-ST	192.168.127.253	0090E823F37D				Serial ID	0120E
EDS-408A-MM-ST	192.168.127.253	0090E823F3D2				Firmware Ver.	1.0.0
EDS-P506A-4POE	172.19.16.252	0090E8209DE1				BuildTime	13112020
EDS-P506A-4POE	192.168.127.253	0090E833DAF6				Release Ver.	1.0.0
VPort26A	172.19.16.88	0090E8262728				Http port	80
VPort P06-1MP-M12-CAM36	192.168.127.6	0090E8334F64					
VPort-461	172.19.16.16	0090E82173D7					
VPort26A	172.19.16.31	0090E8260101					
VPort 16-M12 (Prolan)	172.19.16.59	0090E8060116					
VPort P06-1MP-M12	172.19.16.40	0090E8000003					
VPort P06-1MP-M12-MIC-CAM36 (LED)	172.19.16.51	0090E8060606					
VPort P06HC-1MP-M12-CAM36	172.19.16.27	0090E8060C01					
VPort 351	172.19.16.47	0090E8152C2F					
VPort35	172.19.16.228	0090E8360109					
VPort-461	172.19.16.42	0090E82173B8					

You can double click the selected VPort, or use the IE web browser to access the VPort's web-based manager (web server).

## **Non DHCP Server Network Environment**

If your VPort 16-M12 is connected to a network that does not have a DHCP server, then you will need to configure the IP address manually. The default IP address of the VPort 16-M12 is 192.168.127.100 and the default subnet mask is 255.255.255.0. Note that you may need to change your computer's IP address and subnet mask so that the computer is on the same subnet as the VPort.

To change the IP address of the VPort manually, access the VPort's web server, and then navigate to the **System Configuration** → **Network** → **General** page to configure the IP address and other network settings. Check *Use fixed IP address* to ensure that the IP address you assign is not deleted each time the VPort is restarted.

**Step 2:** Accessing the VPort P06HC-1MP-M12's web-based manager

Type the IP address in the web browser's address input box and then press enter.

**Step 3:** Install the ActiveX Control Plug-in

A security warning message will appear the first time you access the VPort's web-based manager. The message is related to installing the VPort ActiveX Control component on your PC or notebook. Click Yes to install this plug-in to enable the IE web browser for viewing video images.



**NOTE** For Windows XP SP2 or later operating systems, the ActiveX Control component will be blocked for system security reasons. In this case, the VPort's security warning message window may not appear. You should unlock the ActiveX control blocked function or disable the security configuration to enable the installation of the VPort's ActiveX Control component.

**Step 4:** Access the homepage of the VPort P06HC-1MP-M12's web-based manager.

After installing the ActiveX Control component, the homepage of the VPort P06HC-1MP-M12's web-based manager will appear. Check the following items to make sure the system was installed properly:

1. Video Images
2. Video Information

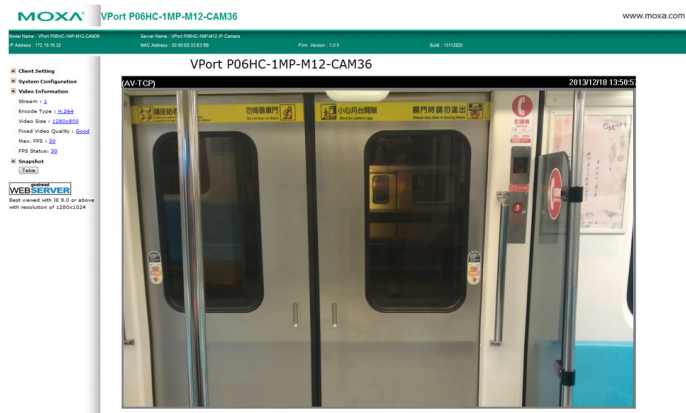

**Step 5:** Access the VPort's system configuration.

Click on **System Configuration** to access the overview of the system configuration to change the configuration. **Model Name**, **Server Name**, **IP Address**, **MAC Address**, and **Firmware Version** appear on the green bar near the top of the page. Use this information to check the system information and installation.

For details of each configuration, check the user's manual on the software CD.

- Home
- Main Menu
- Overview
- System
- Network
- Video
- Audio
- PTZ
- Dynastream
- Alarm

Best viewed with IE 9.0 or above with resolution of 1280x1024

### System Configuration

Welcome to the System Configuration pages. A brief description of each configuration group is given below. Click on a plus sign in the left pane to expand a group, and then click on the name of the page you would like to open.

Category	Item	Description and Content
System	General	Setting Host Name and Date/Time
	Account	Administrator, User and Demo Account Privileges Management
	System Log	System Log and operation information
	System Parameter	System parameter information and Import/Export function
	Firmware Upgrade	Remote Firmware Upgrade
	Factory Default	Reset to Factory Default
	Reboot	Device self-reboot for restoring system
	General	The IP network settings of this VPort
	SMTP Server	Set up Primary and Secondary SMTP Server and E-mail accounts
	FTP Server	Set up the Primary and Secondary FTP Server
Network	DDNS	Configure DDNS
	Universal PnP	Enable UPnP function
	Telnet	Configure Telnet/Type of Service
	Multicast	Set up Multicast (IGMP) Streaming
	HTTP Event Server	Set up the HTTP Event Server to send the event alarm action
	Accessible IP	Set up a list to control the access permission of clients by checking their IP address
	SNMP	Configure the SNMP settings
	Telnet	Configure Telnet
	IGMP	Configure IGMP
	Video	Image Settings
Camera Settings		Configure the attributes of video image
Video Performance		Configure the Stream Main settings
Audio	Audio Setting	Configure the Audio settings
	Process Mark	Configure the Digital PTZ settings
Dynastream	Basic	Configure the Dynastream settings
	Conditions	Configure the Dynastream trigger conditions settings
	Basic Setting	General settings of event alarm
	Schedule	Set up the Alarm schedule
Alarm	Motion Detection	Configure the Motion Detection Alarm
	CGI Event	Configure the CGI event Alarm
	Sequential Snap Shot	Configure the Sequential Snap Shot
	Camera Tamper	Configure the Camera Tamper event Alarm

## Wiring Requirements



### ATTENTION

#### Safety First!

Be sure to disconnect the power cord before installing and/or wiring your Moxa VPort P06HC-1MP-M12. Calculate the maximum possible current in each power wire and common wire. Observe all electrical codes dictating the maximum current allowable for each wire size. If the current goes above the maximum ratings, the wiring could overheat, causing serious damage to your equipment.

You should also pay attention to the following:

- Use separate paths to route wiring for power and devices. If power wiring and device wiring paths must cross, make sure the wires are perpendicular at the intersection point.
- You can use the type of signal transmitted through a wire to determine which wires should be kept separate. The rule of thumb is that wiring that shares similar electrical characteristics can be bundled together.
- Keep input wiring and output wiring separated.
- We strongly advise labeling wiring to all devices in the system.

## Dimensions (mm)

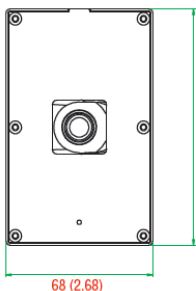

Front View

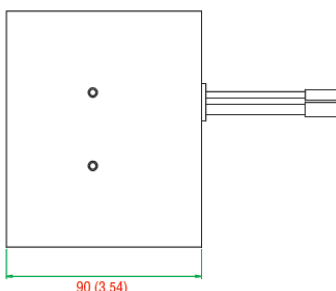

Bottom View

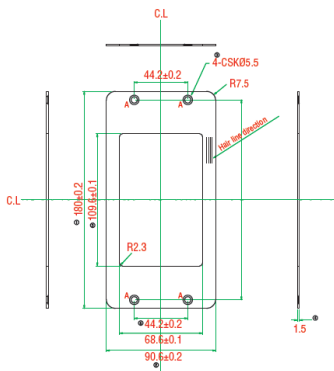

**VP-FD1**  
**(front decorative plate)**

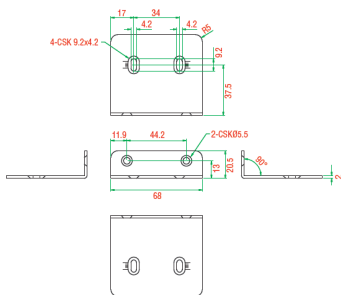

**VPort P06HC's L-type mounting kit**

## Specifications

<b>Camera</b>	
Sensor	1/2.7" HD progressive scan CMOS
Lens	3.6 mm fixed focal length
Angle of view	3.6 mm, F1.6: Diagonal 125°, Horizontal 104°, Vertical 54°
Illumination (Low light sensitivity)	0.2 Lux at F=1.2, color
Synchronization	Internal
White Balance	ATW/AWB (range: 3200 to 10000°K)
Electronic Shutter	Auto, 1/30 to 1/25000 sec.
S/N Ratio	50 dB (Gamma, Aperture, AGC, OFF; DNR ON)
DNR	Built-in DNR
WDR	Level 1 to 8
AGC Control	2X, 4X, 8X, 16X
Flickerless Control	Automatic/ 50Hz/60Hz mode
Black level control	High/Medium/Low
Auto Exposure	Level ±5
Image Rotation	Flip, Mirror, and 180° rotation
Image Setting	Manual tuning with saturation, sharpness, and contrast
<b>Video</b>	
Video Compression	H.264 (ISO/IEC 14496-10) or MJPEG
Video Output	Via Ethernet port
Video Streams	Maximum of 3 video streams (2 H.264 and 1 MJPEG) <ul style="list-style-type: none"> <li>• Stream 1: H.264, 1280 x 800 resolution (max.)</li> <li>• Stream 2: H.264, 720 x 480 resolution (max.)</li> <li>• Stream 3: MJPEG, 720 x 480 resolution (max.)</li> </ul> Note: Streams 2 and 3 must be set to the same resolution

Video Resolution and FPS (Frame per second):

	NTSC		PAL	
	Size	Max. FPS	Size	Max. FPS
QCIF (cropping)	176 x 112	30	176 x 144	25
CIF(cropping)	352 x 240	30	352 x 288	25
VGA(cropping)	640 x 480	30	640 x 480	25
4CIF(cropping)	704 x 480	30	704 x 576	25
Full D1(cropping)	720 x 480	30	720 x 576	25
SVGA(cropping)	800 x 600	30	800 x 600	25
HD(cropping)	1280x720	30	1280x720	25
WXGA	1280x800	30	1280x800	25

*Note: Except for 1280x800, the other resolutions are cropped images.*

Video Viewing	<ul style="list-style-type: none"> <li>• DynaStream™ supported for automatic frame rate adjustment</li> <li>• CBR Pro™ for good image quality in limited bandwidth transmission</li> <li>• 3 configurable privacy mask areas</li> <li>• Adjustable image size and quality</li> <li>• Timestamp and text overlay</li> <li>• OSD (On screen Display) position adjustable</li> <li>• Maximum of 5 simultaneous unicast connections</li> <li>• Digital PTZ with 4x zoom</li> </ul>
---------------	--

**Audio**

Audio inputs	1, built-in microphone
Audio format	Mono, PCM (G.711)

**Network**

Protocols	TCP, UDP, HTTP, SMTP, FTP, Telnet, NTP, DNS, DHCP, UPnP, RTP, RTSP, ICMP, QoS, SNMPv1/v2c/v3, DDNS, TFTP, OPT 66/67
Ethernet	1 10/100BaseT(X) Ethernet port, 4-pin M12 D-code female connector

**GPIO**

Digital Input	1, max. 8 mA Low: +13 V to +30 V; High: -30 V to +3 V
---------------	--

**Power Requirements**

Input	Power-over-Ethernet (IEEE 802.3af)
Consumption	Maximum 6.3W

**Physical Characteristics**

Housing	IP66 rain and dust protection, metal housing with transparent cover
Dimensions	109 x 68 x 90 mm (4.29 x 2.68 x 3.54 in)
Weight	
Installation	Flush mounting

**Environmental Limits**

Operating Temperature	-25 to 55°C (-13 to 131°F)
-----------------------	----------------------------

Storage Temperature	-40 to 85°C (-40 to 185°F)
Ambient Relative Humidity	5 to 95% (non-condensing)
Conformal Coating	Available on request
<b>Regulatory Approvals</b>	
Safety	UL 60950-1
EMI	FCC Part 15 Subpart B Class A, EN 55022 Class A
EMS	EN61000-4-2 (ESD), Level 3 EN61000-4-3 (RS), Level 3 EN61000-4-4 (EFT), Level 3 EN61000-4-5 (Surge), Level 3 EN61000-4-6 (CS), Level 3 EN61000-4-8
Rolling Stock	EN 50155:2007 compliance (shock, vibration, temperature, EMC)
Shock	IEC61373
Freefall	IEC60068-2-32
Vibration	IEC61373
MTBF (Mean-time between failures)	1,275,915 hours (Telcordia, Ground Benign 25°C)
Warranty	5 years
<b>Alarm Features</b>	
<ul style="list-style-type: none"> <li>• Intelligent Video: Camera tamper (Pending)</li> <li>• Video Motion Detection: 3 independently configurable motion areas</li> <li>• Scheduling: Daily repeat timing schedule</li> <li>• Imaging: JPEG snapshots for pre/trigger/post alarm images</li> <li>• Email/FTP Messaging: Automatic transfer of stored images via email or FTP as event-triggered actions</li> <li>• Custom Alarms: HTTP event servers for setting customized alarm actions</li> <li>• Pre-alarm Buffer: 12 MB video buffer for JPEG snapshot images</li> </ul>	
<b>Security</b>	
<ul style="list-style-type: none"> <li>• Password: User level password protection</li> <li>• Filtering: By IP address</li> <li>• Encryption: HTTPS, SSH</li> </ul>	
<b>Minimum Viewing System Requirements</b>	
<ul style="list-style-type: none"> <li>• Pentium 4, 2.4 GHz</li> <li>• 512 MB of memory</li> <li>• Windows XP with SP3 and above, Windows 7</li> <li>• Internet Explorer 9.x or above</li> <li>• DirectX 9.0c or above</li> </ul>	
<b>Software Development Kit</b>	
VPort SDK PLUS	Includes CGI commands, ActiveX Control, and API library for customized applications or system integration for third-party developer
Standard	ONVIF

**Technical Support Contact Information**  
**[www.moxa.com/support](http://www.moxa.com/support)**

Moxa Americas:

Toll-free: 1-888-669-2872

Tel: +1-714-528-6777

Fax: +1-714-528-6778

Moxa Europe:

Tel: +49-89-3 70 03 99-0

Fax: +49-89-3 70 03 99-99

Moxa China (Shanghai office):

Toll-free: 800-820-5036

Tel: +86-21-5258-9955

Fax: +86-21-5258-5505

Moxa Asia-Pacific:

Tel: +886-2-8919-1230

Fax: +886-2-8919-1231