

# UC-8112-ME-T

## Quick Installation Guide

---

Edition 1.1, December 2016

### Technical Support Contact Information

[www.moxa.com/support](http://www.moxa.com/support)

Moxa Americas:

Toll-free: 1-888-669-2872

Tel: 1-714-528-6777

Fax: 1-714-528-6778

Moxa China (Shanghai office):

Toll-free: 800-820-5036

Tel: +86-21-5258-9955

Fax: +86-21-5258-5505

Moxa Europe:

Tel: +49-89-3 70 03 99-0

Fax: +49-89-3 70 03 99-99

Moxa Asia-Pacific:

Tel: +886-2-8919-1230

Fax: +886-2-8919-1231

Moxa India:

Tel: +91-80-4172-9088

Fax: +91-80-4132-1045



© 2016 Moxa Inc. All rights reserved.

P/N: 1802081120011



## Overview

The UC-8112-ME-T computing platform is designed for embedded data acquisition applications. The UC-8112-ME-T computer comes with one or two RS-232/422/485 serial ports and dual 10/100 Mbps Ethernet LAN ports, as well as a Mini PCIe socket to support cellular modules. These versatile communication capabilities let users efficiently adapt the UC-8112-ME-T to a variety of complex communications solutions.

## Package Checklist

Before installing the UC-8112-ME-T, verify that the package contains the following items:

- UC-8112-ME-T embedded computer (with SD card)
- Power jack
- 3-pin terminal block for power
- 5-pin terminal block for UART x 2
- Quick installation guide (printed)
- Warranty card

*IMPORTANT: Notify your sales representative if any of the above items are missing or damaged.*

## UC-8112-ME-T Panel Layout

The following figures show the panel layouts of the UC-8112-ME-T.

### Top Panel View

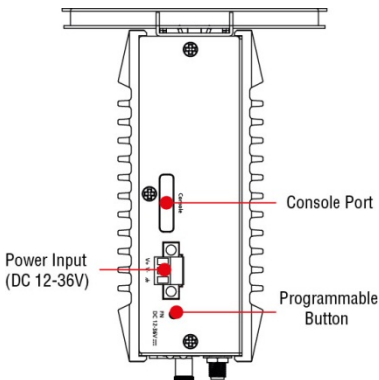



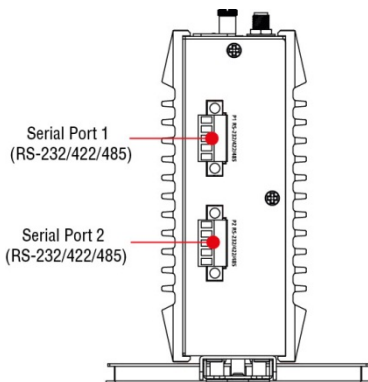

## Bottom Panel View

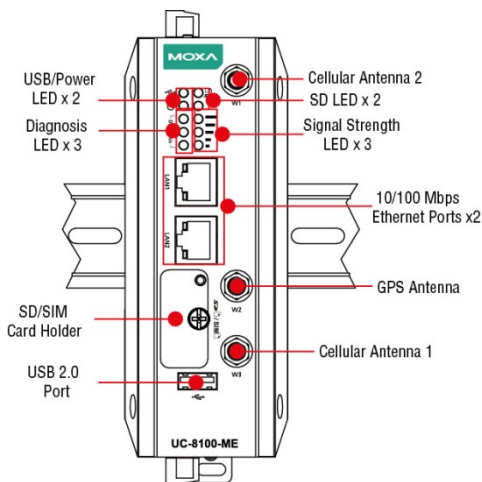



## Front Panel View



## LED Indicators

LED Name	Color	Function
 USB	Green	Steady On   USB device is connected and working normally.
		Off   USB device is not connected.
 SD	Green	Steady On   SD Card inserted and working normally.
		Off   SD card is not detected.
 Power	Green	Power is on and the computer is working normally.
		Off   Power is off.
 LAN1/ LAN 2 (RJ45 connector)	Green	Steady On   100 Mbps Ethernet link
		Blinking   Data transmission in progress
	Yellow	Steady On   10 Mbps Ethernet link
		Blinking   Data transmission in progress
Off   Ethernet is not connected.		

LED Name	Color	Function
	Green Yellow Red	The number of glowing LEDs indicates the signal strength. 3 (Green + Yellow + Red): Excellent 2 (Yellow + Red): Good 1 (Red): Poor
	Off	Wireless module is not detected.
	Green Yellow Red	These three LEDs are programmable. For details, refer to the "Default Programmable Button Operation" section in the <i>Hardware User's Manual</i> .
	Programmable diagnostic LEDs	

## Installing the UC-8112-ME-T

Two sliders are provided at the back of the unit for DIN-rail mounting or wall mounting.

### DIN-Rail Mounting

1. The DIN-rail mounting kit is mounted by default as shown in the figure below.

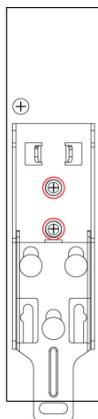

2. Pull down the bottom slider of the DIN-rail bracket located at the back of the unit
3. Insert the top of the DIN rail into the slot just below the upper hook of the DIN-rail bracket.
4. Latch the unit firmly on to the DIN rail as shown in the illustrations below.
5. Push the slider back into place.

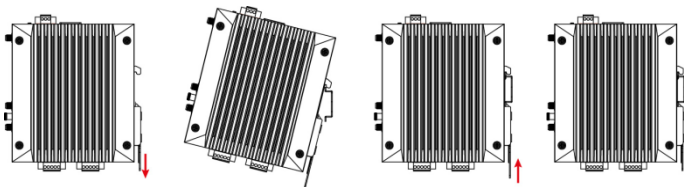

## Connector Description

### Power Connector

Connect the power jack (in the package) to the UC-8112-ME-T's DC terminal block (located on the top panel), and then connect the power adapter. It takes about 30 seconds for the system to boot up. Once the system is ready, the Power LED will light up.

### Grounding the UC-8112-ME-T

Grounding and wire routing help limit the effects of noise due to electromagnetic interference (EMI).

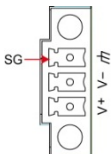

**SG:** The Shielded Ground (sometimes called Protected Ground) contact is the top contact of the 3-pin power terminal block connector when viewed from the angle shown here. Connect the SG wire to an appropriate grounded metal surface.

### Ethernet Ports

The two 10/100 Mbps Ethernet ports (LAN 1 and LAN 2) use RJ45 connectors.

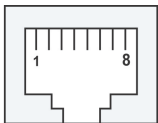

Pin	Signal
1	ETx+
2	ETx-
3	ERx+
6	ERx-

### Serial Ports

The two serial ports (P1 and P2) use terminal connectors. Each port can be configured by software for RS-232, RS-422, or RS-485. The pin assignments for the ports are shown in the following table:

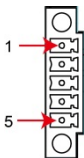

Pin	RS-232	RS-422	RS-485
1	TXD	TXD+	-
2	RXD	TXD-	-
3	RTS	RXD+	D+
4	CTS	RXD-	D-
5	GND	GND	GND

### SD/SIM Card Sockets

The UC-8112-ME-T comes with an SD socket for storage expansion, and a SIM card socket for cellular communication. The SD card/SIM card sockets are located at the lower part on the front panel. To install the cards, remove the screw and the protection cover to access the sockets, and then insert the SD card or the SIM card into the sockets directly. You will hear a click when the cards are in place. To remove the cards, push the cards in before releasing them.

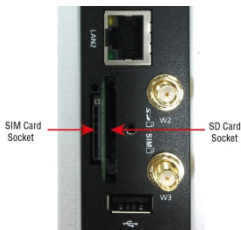

## **Console Port**

The console port is an RS-232 port that can be connected to with a 4-pin pin header cable. You can use this port for debugging or firmware upgrade. Note that the cable is not included in the package.



Pin	Signal
1	TxD
2	RxD
3	NC
4	GND

## **USB**

The USB 2.0 port is located at the lower part of the front panel and supports a USB storage device driver. By default, the USB storage is mounted at `/mnt/usbstorage`.

## **Real-Time Clock**

The real-time clock in the UC-8112-ME is powered by a lithium battery. We strongly recommend that you do not replace the lithium battery without the help of a Moxa support engineer. If you need to change the battery, contact the Moxa RMA service team.



## **ATTENTION**

There is a risk of explosion if the battery is replaced with an incorrect type of battery.

## **Cellular Module**

The UC-8112-ME-T comes with a built-in PCIe socket for wireless communication. To install a cellular module, do the following:

1. Remove the four screws on the DIN-rail mounting bracket and detach the bracket from the unit.
2. Remove the two screws on the rear panel.



3. Remove the four screws on the silver cover on the right panel and remove the cover.



4. Remove the screw on the metal cover.



5. Remove the three screws on the top panel.



6. Remove the two screws on the bottom panel.



7. Check the contents of the cellular module package. The package should contain the items shown below:

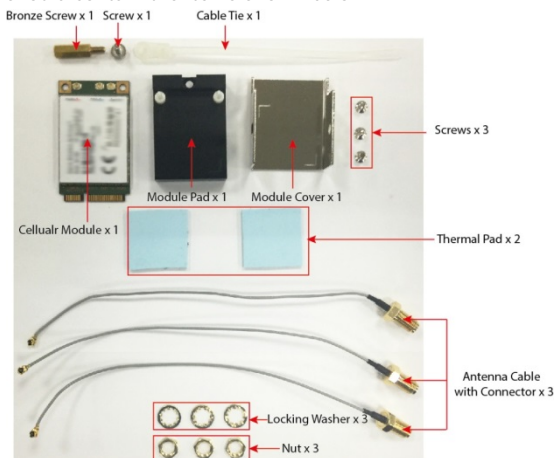

8. Remove the metal cover of the computer and locate the cellular module socket.

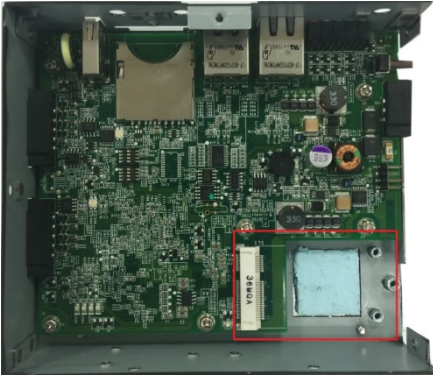

9. Remove the screw next to the socket and replace it with the bronze screw (in the package) as shown below:



10. Attach one thermal pad to the cellular module cover and the other thermal pad to the module pad.





11. Attach the cellular module to the module pad.

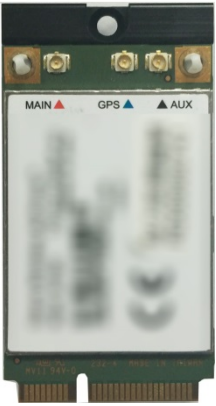

12. Mount the module cover on the cellular module and use screws on both sides to secure the cover.

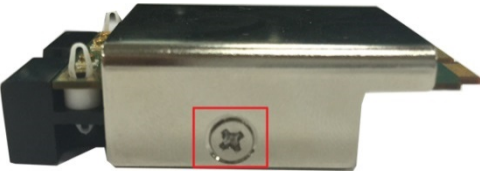

13. Insert the module into the socket and secure it using a screw from the package.

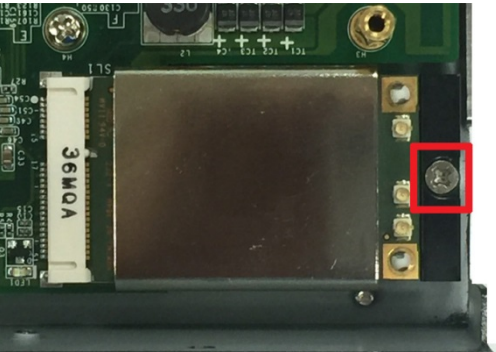

14. Connect antenna cables to the cellular module. There are three antenna connectors on the cellular module: W1 and W3 are for cellular antennas and W2 is for GPS antenna.



15. Insert the antenna connectors through the antenna cable holes on the front panel of the cover as shown below:



16. Secure the antenna connectors to the cover using a locking washer and nut as shown below:

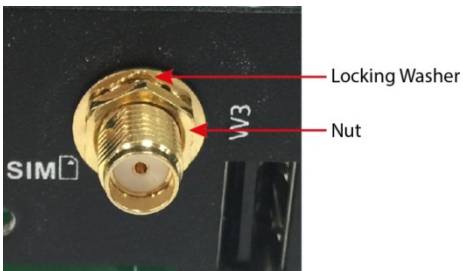

17. Arrange the antenna cables and use a cable tie to attach the cables to the bronze screw. You may cut the cable tie if it is too long.

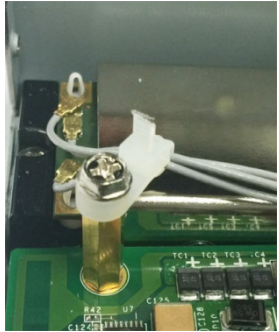

18. Plug the antenna onto the connector.



19. Replace the cover of the computer and fasten the screws to secure the cover.

## Accessing the UC-8112-ME-T Using a PC

You can use a PC to access the UC-8112-ME-T by one of the following methods:

- A. Through the serial console port with the following settings:  
**Baudrate**=115200 bps, **Parity**=None, **Data bits**=8, **Stop bits** =1, **Flow Control**=None



### ATTENTION

Remember to choose the "VT100" terminal type. Use the console cable to connect a PC to the UC-8112-ME-T's serial console port

- B. Using SSH over the network. Refer to the following IP addresses and login information:

	<b>Default IP Address</b>	<b>Netmask</b>
<b>LAN 1</b>	192.168.3.127	255.255.255.0
<b>LAN 2</b>	192.168.4.127	255.255.255.0

**Login:** moxa

**Password:** moxa