

Moxa MxNVR-MO4 Industrial Video Recorder User's Manual

Second Edition, February 2013

www.moxa.com/product



© 2013 Moxa Inc. All rights reserved.
Reproduction without permission is prohibited.

Moxa MxNVR-MO4 Industrial Video Recorder User's Manual

The software described in this manual is furnished under a license agreement and may be used only in accordance with the terms of that agreement.

Copyright Notice

Copyright ©2013 Moxa Inc.
All rights reserved.
Reproduction without permission is prohibited.

Trademarks

The MOXA logo is a registered trademark of Moxa Inc.
All other trademarks or registered marks in this manual belong to their respective manufacturers.

Disclaimer

Information in this document is subject to change without notice and does not represent a commitment on the part of Moxa.

Moxa provides this document as is, without warranty of any kind, either expressed or implied, including, but not limited to, its particular purpose. Moxa reserves the right to make improvements and/or changes to this manual, or to the products and/or the programs described in this manual, at any time.

Information provided in this manual is intended to be accurate and reliable. However, Moxa assumes no responsibility for its use, or for any infringements on the rights of third parties that may result from its use.

This product might include unintentional technical or typographical errors. Changes are periodically made to the information herein to correct such errors, and these changes are incorporated into new editions of the publication.

Technical Support Contact Information

www.moxa.com/support

Moxa Americas

Toll-free: 1-888-669-2872
Tel: +1-714-528-6777
Fax: +1-714-528-6778

Moxa Europe

Tel: +49-89-3 70 03 99-0
Fax: +49-89-3 70 03 99-99

Moxa China (Shanghai office)

Toll-free: 800-820-5036
Tel: +86-21-5258-9955
Fax: +86-21-5258-5505

Moxa Asia-Pacific

Tel: +886-2-8919-1230
Fax: +886-2-8919-1231

Table of Contents

1. Preface	1-1
Before Getting Started	1-1
Important Note	1-1
2. Introduction	2-1
Overview	2-2
Package Checklist	2-4
Product Features	2-4
Typical Application	2-5
Panel Layout of the MxNVR-MO4.....	2-6
Product Description.....	2-7
BNC video input.....	2-7
DB9 male connector for audio inputs.....	2-7
LED Indicators.....	2-8
10/100Mbps M12 Ethernet port	2-8
12/24 VDC M12 power input.....	2-9
GPIO (General purpose I/O).....	2-9
RS-232 Console Port	2-10
Reset Button	2-10
3. Getting Started	3-1
Before Getting Started	3-2
First-Time Installation and Configuration	3-2
RS-232 Console Configuration (115200, None, 8, 1, VT1 00).....	3-8
Mounting the MxNVR-MO4 Dimension.....	3-11
Panel Mounting	3-12
DIN-Rail mounting (with optional Kit)	3-13
Wiring Requirements.....	3-14
Grounding the MxNVR-MO4	3-14
4. Accessing the MxNVR-MO4's Web-based Manager	4-1
Functions Featured on the MxNVR-MO4's Web Homepage.....	4-2
MxNVR's Information	4-2
Server Name	4-2
Camera Image View	4-2
Client Settings	4-2
System Configuration	4-3
Video Information	4-4
Snapshot.....	4-4
Relay Control.....	4-4
Video Recording with the MxNVR-MO4.....	4-4
Step 1: Initialize the HDD or SSD.....	4-4
Step 2: Configure the Video Recording mode, channel, stream, and schedule	4-4
Step 3: Click on SAVE, and then MxNVR-MO4 will start to run the video recording.....	4-5
Retrieve the Recorded Video from MxNVR-MO4	4-5
Step 1: Setup the FTP server daemon	4-5
Step 2: Access into MxNVR-MO4's FTP server.....	4-5
Step 3: Download the recorded videos	4-6
Stop the Video Recording.....	4-6
Status of the hard disk.....	4-7
5. System Configuration	5-1
System Configuration by Web Console	5-2
System	5-3
General Settings	5-3
Account Privileges	5-4
Local Storage	5-5
System Diagnosis	5-7
System Log History	5-7
System Parameters	5-8
Firmware Upgrade	5-9
Reset to Factory Default	5-10
Reboot	5-10
Network.....	5-10
General Network Settings	5-10
SMTP Server and Email Account Settings	5-14
FTP Server Settings.....	5-16
Dynamic DNS	5-17
Universal PnP	5-17
Multicast.....	5-18
Configuring Multicast Settings	5-19

Accessible IP List	5-20
SNMP	5-21
Configuring SNMP Settings.....	5-21
SNMP Read/ Write Settings	5-22
QoS (ToS).....	5-23
HTTP Event Server	5-24
Modbus/TCP	5-25
IEEE 802.1X.....	5-25
DynaStream™	5-26
Basic	5-26
Conditions.....	5-27
Video	5-28
Image Settings	5-28
Camera Modulation	5-29
Video Performance	5-29
Audio	5-31
Audio Source.....	5-31
Alarm	5-31
System Alarm.....	5-31
Event Alarm	5-32
Basic	5-33
Schedule.....	5-34
Video Motion Detection	5-35
Digital Input.....	5-37
Video Loss	5-39
CGI Event	5-40
Sequential Snapshot	5-41
A. Frequently Asked Questions.....	A-1
B. ModBus Address Table	B-1
C. Time Zone Table	C-1
D. Technical Specifications	D-1

Before Getting Started

Before using your MxNVR-MO4, please pay close attention to the following instructions:

- ❑ After opening the MxNVR-MO4 box, compare the contents of the box with the **Package Checklist in Chapter 1**. Notify your sales representative if any of the items are missing or damaged.
- ❑ To prevent damage or problems caused by improper use, read the **Quick Installation Guide** (the printed handbook included in the package) before assembling and operating the device and peripherals. You may also refer to **Chapter 1**, under **Product Description**, and all of **Chapter 2**, of this manual.
- ❑ The MxNVR-MO4 has been designed for various environments and can be used to build various applications for general security or demonstration purposes. For standard applications, refer **Chapter 2, Getting Started**, and **Chapter 3, Accessing the MxNVR-MO4 Video Recorder for the First Time**.

Important Note

- ❑ Surveillance devices may be prohibited by law in your country. Since MxNVR-MO4 is both a high performance surveillance system and networked video server, verify that the operations of such devices are legal in your locality before installing this unit for surveillance purposes.

Introduction

The MxNVR-MO4 is a streaming video recorder designed for use in a mobile video surveillance environment. In addition to being able to handle basic video feeds and recording, the MxNVR-MO4 also includes many advanced features for setting up surveillance or web multimedia applications.

The following topics are covered in this chapter:

- ❑ **Overview**
- ❑ **Package Checklist**
- ❑ **Product Features**
- ❑ **Typical Application**
- ❑ **Panel Layout of the MxNVR-MO4**
- ❑ **Product Description**

Overview

The MxNVR-MO4 is a streaming DVR (digital video recorder), which can transmit and record H.264 or MJPEG video streams simultaneously. With a rugged design that meets EN 50155 criteria for power characteristics, EMC, vibration, shock and temperature (T model, TX temperature level), the MxNVR-MO4 especially excels in rolling stock IP video surveillance applications. Moreover, the MxNVR-MO4 has passed EN 61373 standard anti-vibration testing with a 2.5 inch hard disk (purchased separately), delivering highly reliable storage performance for rolling stock applications. The MxNVR-MO4 can be triggered to record by system boot, by event, by schedule, or by external commands, such as CGI or SNMP. The embedded DynaStream™ function increases the network transmission efficiency by dynamically adjusting the video frame rate. To prevent unauthorized access, advanced 802.1X authentication is available to provide high network security. The MxNVR-MO4 also supports the OnVIF standard to easily integrate and interoperate with third party systems and software.

High performance H.264/MJPEG compression

Video input can be efficiently compressed into H.264/MJPEG video stream packets in real time. This is done without sacrificing remote monitoring capability or storage. Five levels of compression quality and four different image resolutions provide greater versatility.

Dual video streams for meeting versatile application requirements

The MxNVR-MO4 is a powerful streaming video recorder. Aside from the high quality H.264 video compression, it can also generate a maximum of two video streams: one H.264 and one MJPEG simultaneously, to meet the needs of specific applications. For example, the user can view the h.264 video streams with full D1 (720x576) resolution at 20FPS and record the MJPEG video streams with CIF (352x288) resolution at 20 FPS.

NOTE	When using simultaneous H.264 and MJPEG video streaming at Full D1 (720x576) resolution, the total FPS of these 2 video streams will be about 25-30 FPS. For example, if MJPEG is set to 10 FPS, then H.264 must be set at 20 FPS.
-------------	--

Easy-to-use video recording functions

The MxNVR-MO4 supports both IP video streaming and local video recording. With the built-in SATA interface, the user can attach one 2.5-inch hard disk or SSD (solid state disk) to record the video streams in a continuous record, event record, or 24-hour daytime schedule record. All of these recording behaviors are easy to set up and automatically executed once the MxNVR-MO4 is powered.

Moxa DynaStream™ for network efficiency

DynaStream™ is a unique and innovative function that allows for adaptive frame rates in response to events on the network, such as event triggers and system commands. When network traffic becomes congested, DynaStream™ allows MxNVR-MO4 or MxNVR-MO series products to respond to CGI, SNMP, and Modbus commands from SCADA and automatically decrease video frame rates to reduce bandwidth consumption. This reserves bandwidth for the SCADA system to maintain Quality of Service (QoS) and guarantees that the SCADA performance will not be impacted by video traffic. For example, the frame rate can be set low during regular streaming to reduce bandwidth usage and automatically switch to a high frame rate during triggered events to ensure quick transmission of critical video data or video streams, or to provide detailed visual images for problem analysis.

Low video latency: under 200 ms (milliseconds)

For some mission-critical applications, low video latency is one of the key requirements. For example, highway transportation systems monitor very fast moving vehicles; videos displayed at the central traffic control center need to reflect the latest traffic conditions. Therefore, the video latency must be under 200ms.

Two audio inputs supported for a complete surveillance solution

The MxNVR-MO4 supports two audio inputs for audio streaming from the field site. These 2 audio streams will be synchronized with the video streams for complete video/audio surveillance applications.

Rugged design for industrial environments

The MxNVR-MO4 is an industrial video recorder, which means that it is designed for harsh industrial environments. It is compliant with the most essential sections of the EN 50155 standard: EMC, shock, vibration and temperature criteria (T model supports TX temperature level with -40 to 75°C operating temperature; SSD required). Most importantly, the MxNVR-MO4 passes IEC/EN 61313 vibration testing using a built-in 2.5" hard disk, which makes it a highly reliable mobile digital video recorder.

Modbus/TCP supported for convenient communication with SCADA/HMI

Most automation applications use SCADA/HMI systems to monitor and control field site devices and equipment. Many SCADA/HMI systems now require real-time video for remote monitoring, and for this reason, the MxNVR-MO4 supports the Modbus/TCP protocol, which enables direct communication between the MxNVR-MO4 and the SCADA/HMI system, allowing administrators to easily determine the status of their MxNVR-MO4s for maintenance purposes.

RTSP streaming for easy integration

RTSP (Real-time Streaming Protocol) is a client-server multimedia presentation control protocol, which enables the interoperability of video devices and software. Hardware or software that supports RTSP streaming can easily identify and decode the video stream without the hassle of codec installation. For example, users can view video images from the MxNVR-MO4 directly with Quick Time and VLC, both of which support RTSP streaming.

Multicast (IGMP) transmission for network efficiency

Transmitting digital video images via an IP network requires many times the bandwidth required for transmitting general data. For this reason, the efficiency of network bandwidth management is one of the most important factors that determine the performance of a video over IP surveillance system. The MxNVR-MO4 364 supports multicast transmission with the IGMP protocol, which can reduce the bandwidth requirements when multiple clients access the same video stream, and greatly increases the efficiency of network bandwidth management.

Easy web access using standard browsers

There is no need to install new software to access the video recorder, since the embedded web server allows users to use any popular web browser to access the video recorder from anywhere over the Internet. As long as you are connected to the network, you will be able to view the same images seen by your cameras.

Built-in 3 area-selectable Video Motion Detection (VMD)

External sensors are not required, since the video channel can be configured to detect motion in 3 areas, making it easy to set up a security system either in your office or in the field. And the customizable settings allow you to tune the system for both object size and sensitivity, making the video recorder adaptable to different environments.

Weekly schedule for automated surveillance

The user-defined time period will check security settings on a weekly basis, and send notifications or drive external devices, making the MxNVR-MO4 suitable for more versatile applications.

Flexible I/O control for external devices

4 opto-isolated sensor inputs and 1 relay outputs are provided to control external devices, giving system integrators the option of turning an analog system into an advanced security system.

SDK support for developers

The high-performance video recorder can be integrated into many applications—without busting your budget—and the complete programming interface of the Moxa VPort SDK PLUS makes the developer's job easy and straightforward. To ask about SDK requirements, please contact a Moxa sales representative for details and an application form.

Package Checklist

The Moxa MxNVR-MO4 is shipped with the following items. If any of these items are missing or damaged, please contact your sales representative for assistance.

- MxNVR-MO4.
- Panel mounting kit and 6 screws
- 4 hard disk screws
- Quick installation guide.
- Documentation & software CD
- Warranty card

Note: If any of these items are missing or damaged, please contact your service representative for assistance

NOTE This product must be installed in compliance with your local laws and regulations.

NOTE The 2.5-inch hard disk or SSD (solid state disk) are not included in the standard shipment. The user must purchase the storage disk separately from a vendor.

NOTE For 35mm DIN-Railing mounting, a DK-DC50131 DIN-Rail mounting kit is required, which it is ordered separately.

Product Features

High Performance Video/Audio Networking Solution

- Compatible with NTSC/PAL analog video cameras
- H.264 and MJPEG video compression standards
- Dual simultaneous video streams (1 H.264 and 1 MJPEG)
- Lower latency, under 200 ms
- 4 BNC video inputs
- Single video stream up to 30 frames/sec in Full D1 (720 x 480) resolution in NTSC, and 25 frames/ sec in Full D1 (720 x 576) resolution in PAL
(If both a H.264 and a MJPEG video stream are transmitted, the total frame/second of these two streams combined is 30.)
- Select between Full D1/ 4CIF/ VGA/ CIF/ QCIF resolutions
- 2 audio inputs with line-in or microphone-in supported for complete video/audio surveillance
- TCP, UDP, and HTTP network transmission modes
- Standard RTSP (Real-time streaming protocol) for easy integration
- DynaStream™ for automatic frame rate adjustment to control IP video traffic
- Multicast (IGMP) protocols for efficient network transmission
- QoS (TOS) for priority transmission
- SNMP V1/V2c/V3 for network management
- Supports Modbus/TCP for easy SCADA communication
- Built-in web server and RS-232 console for remote access and configuration
- One auto-sensing 10/100BaseT(X) or 100BaseFX (M12 connector) Ethernet port
- 8 output video streams and 8 client connections
- 50 multicast clients for receiving multicast video streams
- Multicast push for all the clients
- Video quality in CBR (constant bit rate) or VBR (variable bit rate)
- UPnP and IP filtering
- ONVIF supported for standardization and interoperability

Easy-to-use Video/Audio Recording Functions

- Recording modes: Continuous, scheduled, event trigger, and external trigger
- Recording capability: Total 120 frames/second H.264 or 60 frames/second for 4-channel videos
- Disconnected recording can be retrieved once the power input is recovered.
- Recorded video can be downloaded via FTP. Users don't need to remove the hard disk.
- Videos recorded in AVI format (compatible with popular media players)
- Alarm notification for recording failures

Rugged Industrial Design

- High reliability with embedded system design, no heater and fan, and low power consumption
- -40 to 75°C operating temperature for harsh industrial environments ("T" models) (Solid State Disk required)
- Anti-vibration with M12 connectors for Ethernet and power input, DB9 connectors for audio inputs and DI/DO
- Panel mounting or 35mm DIN-rail mounting (with mounting kits)
- Compliant with essential sections of EN 50155: power, EMC, vibration, shock, and Class TX temperature (T model)
- Passed the EN50155 vibration test (EN 61373) with a general 2.5-inch hard disk (This hard disk is not included in standard shipment, need to be purchased by the user)
- CE, FCC, and UL60950-1

Intelligent Alarm Trigger

- Supports system alarms, including network link
- Supports event alarms, including video motion detection (VMD), video loss, digital input, and CGI event
- Equipped with 4 DIs and 1 relays (DO) for external sensors and alarms.
- Pre, trigger, and post alarm snapshot images provided.
- 16 MB video buffer for JPEG snapshot images
- Supports sequential snapshot images
- Messages with snapshot images can be sent via FTP and email.
- Capable of setting an alarm schedule

Video Management and Control

- Free Moxa MXNVR-MO4 SDK PLUS support with flexible interface and sample code for customized applications or system integration

NOTE If you are interested in Moxa's VPort SDK PLUS, please go to Moxa's website www.moxa.com to download the package, or contact a Moxa sales representative for more information about this SDK

Typical Application

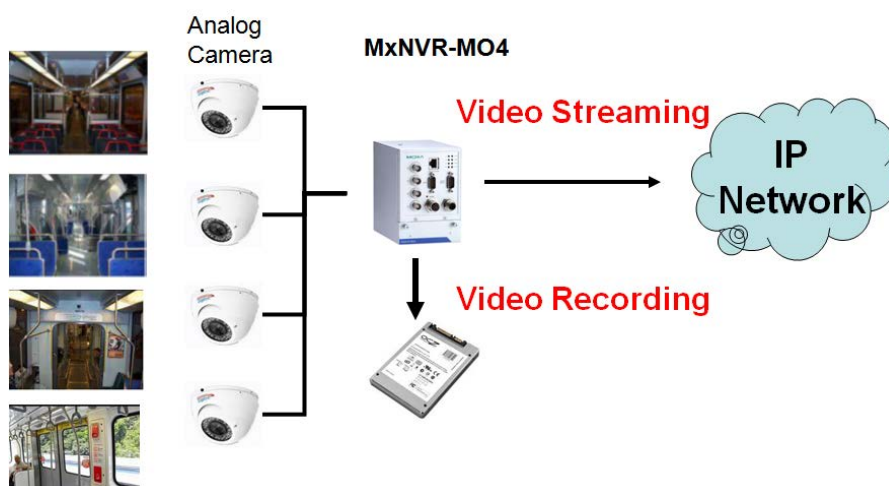

Panel Layout of the MxNVR-MO4

Front View

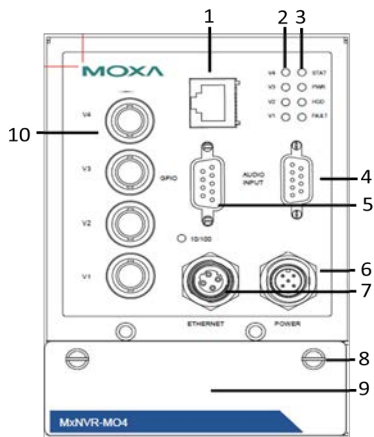

1. RS-232 console port
2. LEDs for V1 to V4
3. LEDs for STAT, PWR, HDD, and FAULT
4. DB9 male connector for 2 audio inputs (line-in port)
5. DB9 male connector for 4 digital inputs and 1 relay output
6. 5-pin M12 A-code connector for one 12/24VDC power input
7. 4-pin M12 D-code connector for 10/100 Mbps Ethernet connector
8. 2 thumbscrews for loosening and pulling out the HDD tray
9. HDD (hard disk) tray
10. 4 BNC connector for V1 to V4 video inputs
11. Ground screw
12. Hard reset button
13. Screw hole for wall mounting
14. Screw hole for DIN-Rail mounting

Top View

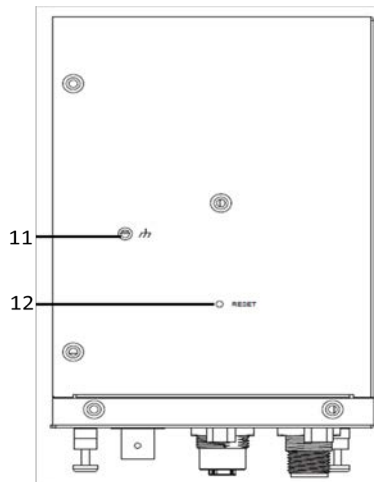

Back View

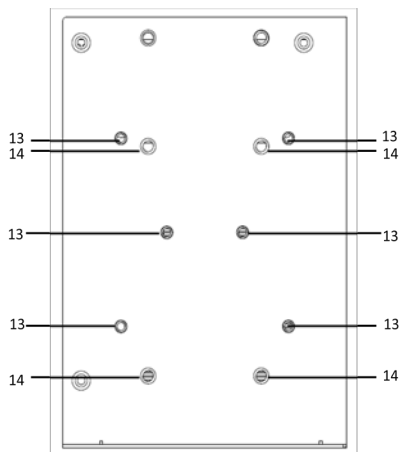

Product Description

BNC video input

The BNC video input is a 1Vpp, 75-ohm video port for connecting an external camera. To ensure that the correct video modulation type is detected, the cameras should be connected and powered on before the MxNVR-MO4 is powered on.

NOTE Please use a standard CCTV cable (RG59U or above) to connect the video camera to the MxNVR-MO4's BNC connector.

DB9 male connector for audio inputs

The MxNVR-MO4 has one DB9 male connector for 2 audio inputs on the front panel. These 2 audio inputs are for the MIC-in/Line-in connection, which can be directly connected with a microphone or an audio source from an amplifier.

The MxNVR-MO4 has 2 audio line-in inputs with DB9 male connector. A pre-amplifier is required, and the audio format is Mono, G.711.

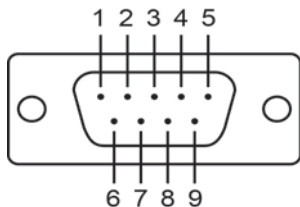

PIN	Definition	Description
1	GND	Ground
2	A1+	Audio 1 +
3	–	Not in use
4	A2+	Audio 2 +
5	GND	Ground
6	A1-	Audio 1 -
7	GND	Ground
8	GND	Ground
9	A2-	Audio 2 -

LED Indicators

The front panel of the MxNVR-MO4 contains several LED indicators. The function of each LED is described in the table below.

LED	Color	State	Description
STAT	Green/Red	Steady Red	Hardware initialization stage.
		Flashing Red	Software initialization stage.
		Steady Green	System has booted up and is ready to run.
		Flashing Green	Firmware is being upgraded.
PWR	AMBER	On	Power is being supplied through power input
		Off	Power is not being supplied through power input
HDD	AMBER	On	The hard disk is installed properly
		Flash	The hard disk is in read/write state
		Off	The hard disk is not installed or failed to initiate
FAULT	RED	On	Once the network is disconnected, the fault LED will be lit in red
		Off	The network link is normal
V1 V2 V3 V4	GREEN	On	Video signal is detected
		Off	Video signal is not detected
10/100	AMBER	On	10 Mbps link is active
		Blinking	Data is being transmitted at 10 Mbps
		Off	10 Mbps link is inactive
	GREEN	On	100 Mbps link is active
		Blinking	Data is being transmitted at 100 Mbps
		Off	100 Mbps link is inactive

10/100Mbps M12 Ethernet port

The MxNVR-MO4 video recorder has 1 10/100M Ethernet port with a 4-pin M12 D-code connector. The 10/100 LED on the left corner of the port indicates the link in 10Mbps or 100Mbps.

The 10/100BaseT(X) Ethernet connector (4-pin shielded M12 connector with D coding) located on the MxNVR-MO4's front panel is used to connect to Ethernet-enabled devices.

Most users configure these ports for Auto MDI/MDI-X mode, in which case the port's pinouts are adjusted automatically depending on the type of Ethernet cable used (straight-through or cross-over), and the type of device (NIC-type or HUB/Switch-type) connected to the port.

The 10/100BaseT(X) port of the MxNVR-MO4 is an MDI port, which means that you should use a cross-over Ethernet cable to connect to the MDI NIC port, and a straight-through Ethernet cable to connect to the MDI-X HUB/Switch port.

Pinouts for the 10/100BaseT(X) Ports

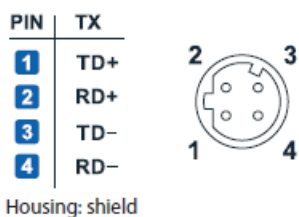

12/24 VDC M12 power input

The MxNVR-MO4 has one power input, which is located on the 5-pin M12 A-code connectors. Below is its pin assignment.



Configuration:05 Pins
 System: Connector(M)
 Mating Cable :Socket (F)
 Code : A-polarization

PIN	Definition
1	V+
2	---
3	V-
4	---
5	GND

STEP 1: Plug your power cord connector to the power input port of the MxNVR

STEP 2: Screw the nut on your power cord connector to the power input connector on the MxNVR to ensure a tight connection.



ATTENTION

The power for this product is intended to be supplied by a Listed Power Unit, with output marked LPS, and rated to deliver 12 to 32 VDC with a maximum power consumption of 11W (including the 2.5" Hard disk).



ATTENTION

Before connecting the VPort to the DC power inputs, make sure the DC power source voltage is stable.

GPIO (General purpose I/O)

The MxNVR-MO4 has four digital inputs and one relay output, which is located on the GPIO port with 9-pin DB9 male connector. Below is its pin assignment.

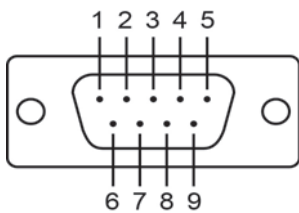

PIN	Definition
1	DI1
2	GND
3	DI3
4	NC
5	NO
6	DI2
7	GND
8	DI4
9	C

MxNVR-MO4 has four sets of digital input, DI1, DI2, DI3 and DI4. Each DI consists of two contacts of the 9-pin DB9 connector: DI (positive wire) and GND (negative wire). These 4 digital inputs can connect with the external sensor or device as the alarms.



ATTENTION

The current and power capacity of the digital input is:

- Max. 8 mA
- High: +13 V to +30 V
- Low: -30 V to +3 V

MxNVR-MO4 has one relay output with 3 contacts: NC (Normal close), NO (Normal close) and C (Common), which can be set up for:

- System alarm: Power failure and Network disconnected.
- Event alarm: VMD (Video Motion Detection) , Video loss, Digital Inputs and CGI Event



ATTENTION

The current and power capacity of the relay output is a maximum of 24 VDC @ 1A. You should be careful not to exceed this power specification.

RS-232 Console Port

The MxNVR-MO4 has one RS-232 (10-pin RJ45) console port located on the top panel. Use either an RJ45-to-DB9 cable or RJ45-to-DB25 cable to connect the MxNVR-MO4's console port to your PC's COM port. You may then use a console terminal program, such as Moxa PComm Terminal Emulator, to access the MxNVR-MO4's console configuration utility.

RJ45 (10-pin) Console Port Pinouts

Pin	Description
1	---
2	DSR
3	---
4	GND
5	TxD
6	RxD
7	GND
8	---
9	DTR
10	---

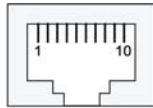

Reset Button

A recessed RESET button is provided for rebooting and restoring the system to the factory default settings. Use a pointed object, such as a straightened paper clip or toothpick, to press the reset button.

Reboot:

To reboot the MxNVR-MO4, power it off and then power it back on again, or push the RESET button one time. The STAT LED will light in red as the POST (Power On Self Test) process runs. When the rebooting process is finished, the STAT LED will turn green.

Restore to Factory Settings:

A recessed RESET button is provided for restoring the system to the factory default settings. When the system fails to install properly, or operates abnormally, use the RESET button located on the top panel of the MxNVR-MO4 to restore the factory defaults.

To do this, use a pointed object such as a straightened paper clip or toothpick to hold down the reset button, and then release the reset button when the STAT LED stops flashing in red. At this point, the POST process will run, and the MxNVR-MO4 will reboot. The STAT LED will turn green when the MxNVR-MO4 has finished rebooting.

Getting Started

This chapter includes information about how to install a MxNVR-MO4 video recorder.

The following topics are covered in this chapter:

❑ **Before Getting Started**

❑ **First-Time Installation and Configuration**

- RS-232 Console Configuration (115200, None, 8, 1, VT1 00)

❑ **Mounting the MxNVR-MO4 Dimension**

- Panel Mounting
- DIN-Rail mounting (with optional Kit)

❑ **Wiring Requirements**

- Grounding the MxNVR-MO4

Before Getting Started

In what follows, “user” refers to those who can access the video recorder, and “administrator” refers to the person who knows the root password that allows changes to the Video Recorder’s configuration, in addition to providing general access. Administrators should read this part of the manual carefully, especially during installation.

First-Time Installation and Configuration

Before installing the MxNVR-MO4, check to make sure that all the items on the package checklist are in the box. In addition, you will need access to a notebook computer or PC equipped with an Ethernet port.



ATTENTION

The MxNVR-MO4 series are high-performance video recorders designed to perform without a cooling fan. Therefore, it is recommended that each MxNVR-MO4 be installed with at least a 5 mm clearance on all surfaces for effective heat-dissipation.



WARNING

- This equipment is intended to be used in a Restricted Access Location, such as a cabinet or a dedicated computer room. Access should only be allowed to SERVICE PERSONS or USERS who have been instructed on proper handling of the device’s metal chassis, which becomes extremely hot. Further, access should be restricted through the use of a key or secure identity system, to ensure only qualified personnel have access to the restricted access location.
- External metal parts are hot!! Before touching it, special attention or protection is necessary.

Step 1: Select the power source

The MxNVR-MO4 can be powered by a 12 to 32 VDC DC power input. One A-code 5-pin M12 connector power input is provided. Users can check the LED status located in the front panel to see if the power input is connected appropriately.

NOTE The MxNVR-MO4 series supports power input specifications of 12-32 VDC for 12/24 VDC power input (note that this is different from Moxa EDS switch’s 12-45 VDC power input).

Step 2: Connect the MxNVR-MO4 to a Network

The MxNVR-MO4 has one auto-sensing 10/100 Mbps Ethernet port in 4-pin M12 D-code connector. A 10/100 LED indicator located at the top indicates a 10 Mbps or 100 Mbps Ethernet connection.

Step 3: Connect the MxNVR-MO4 to cameras and an audio source

The MxNVR-MO4 has four VIDEO INPUT ports (V1, V2, V3, and V4). Use the BNC connector (1.0 Vpp, 75Ω) and coaxial cable to connect video cameras to the VPort to input analog video signals.

The MxNVR-MO4 has 2 line-in or mic-in audio inputs, DB9 male connector. A microphone or amplifier can be plugged directly into the AUDIO INPUT port.

NOTE Four VIDEO LEDs (V1, V2, V3, V4) are located on the MxNVR-MO4’s front panel to indicate the video signal transmission status for video inputs. Check the LED status to see if the video is working properly.



ATTENTION

A ground loop isolator is recommended to be used between the camera and the MxNVR-MO4 to avoid a sudden current that burns out the VPort's chips and boards, generated by the electric potential difference between these two device's ground power.

Step 4: Install the 2.5" HDD (hard disk) or SSD (solid state disk)

The MxNVR-MO4 has a HDD tray located in the bottom. There are few steps to install the HDD or SSD.

NOTE

It is recommended to remove the power input before installing the hard disk.

1. Loosen the 2 thumbscrews and use them to pull out the HDD tray.

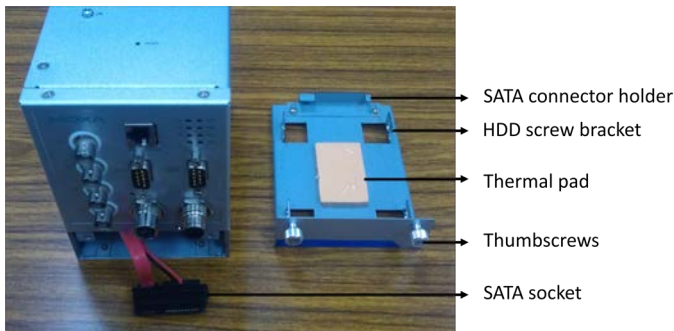

2. Remove the protective membrane of the thermal pad located on the top of the HDD tray.

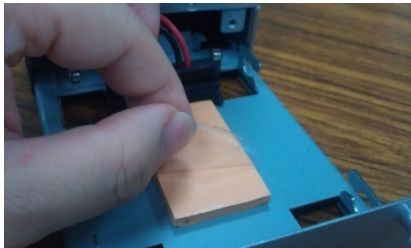

3. Install the 4 yellow anti-vibration pads into the 4 HDD screw brackets, and loosen the 2 screws of the SATA connector holder

Anti-vibration pad



4. Connect the 2.5-inch HDD or SSD with the SATA socket, and then screw the 4 HDD screws on it with the HDD tray.



5. Remove the protective membrane of the thermal pad located on the bottom of the HDD tray.

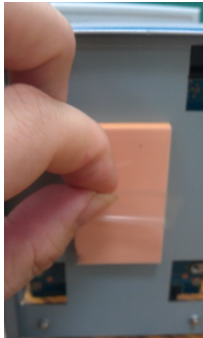

6. Push the HDD tray back into the MxNVR-MO4, and then fix the 2 thumbscrews to complete the installation.

NOTE When pushing the HDD tray back into MxNVR-MO4, please be careful not to damage the SATA cable.

NOTE The MxNVR-MO4 is designed for high-vibration environments. For best results when using a normal 2.5 inch hard disk, we recommend the Toshiba MK series 2.5-inch hard disk. The 2.5-inch hard disk used in the MxNVR-MO4 to pass the vibration criteria of EN/IEC 61373 was the Toshiba MK1059GSM (1 TB).

NOTE For using MxNVR-MO4-T in -40 to -75°C environments, a SSD (solid state disk) with -40 to 75°C operating temperature capability is required. The SSD installed in the MxNVR-MO4 used to pass the -40 to 75°C operating temperature tests was an Intel SSD.

Step 5: Configure the MxNVR-MO4's IP address

After powering on the MxNVR-MO4, wait a few seconds for the POST (Power On Self Test) to run. The STAT LED turns green to indicate that the POST process has completed. The IP address will be assigned when the 10 or 100 Mbps NETWORK LED blinks. The IP address assigned after the POST is completed depends on the network environment.

Network Environment with a DHCP Server

In this case, the IP address of the MxNVR-MO4 is assigned by a DHCP Server. Use the DHCP Server's IP address table, or use the Moxa MxNVR-MO4 utility to determine the IP address that was assigned by the DHCP Server.

NOTE After powering on the MxNVR-MO4, wait a few seconds for the POST (Power On Self Test) to run. The IP address will be assigned when the 10 or 100 Mbps NETWORK LED blinks.

Using the **Moxa Ethernet Switch And Video Server Configuration Utility (edscfgui.exe)**, as described below:

1. Run the **edscfgui.exe** program to search for the MxNVR-MO4 and EDS switches. After the Utility window opens, you may also select or click on Broadcast Search, which is located under the List Server menu, to initiate a search (note that you can also click on the Broadcast Search icon  to initiate a search.

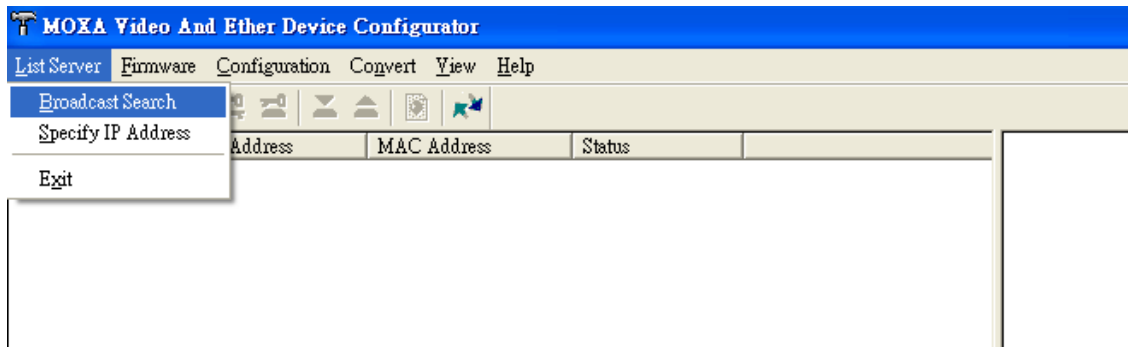

NOTE You may download the Moxa Ethernet Switch And Video Server Configuration Utility (edscfgui.exe) software from Moxa's website at www.moxa.com.

2. The **Broadcast Search** window will show a list of all switches and MxNVR-MO4 located on the network. The progress of the search will also be displayed.

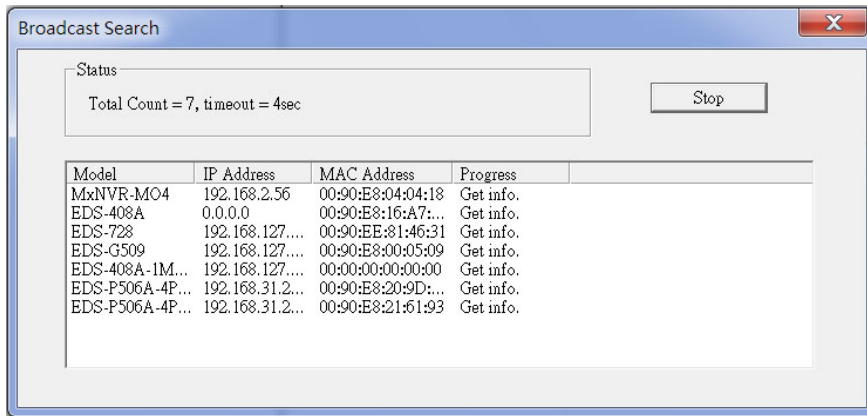

3. When the search has ended, the Model Name, MAC address, and IP address of the EDS switches, VPort IP cameras/video servers, and MxNVR video recorders will be listed in the Utility window.

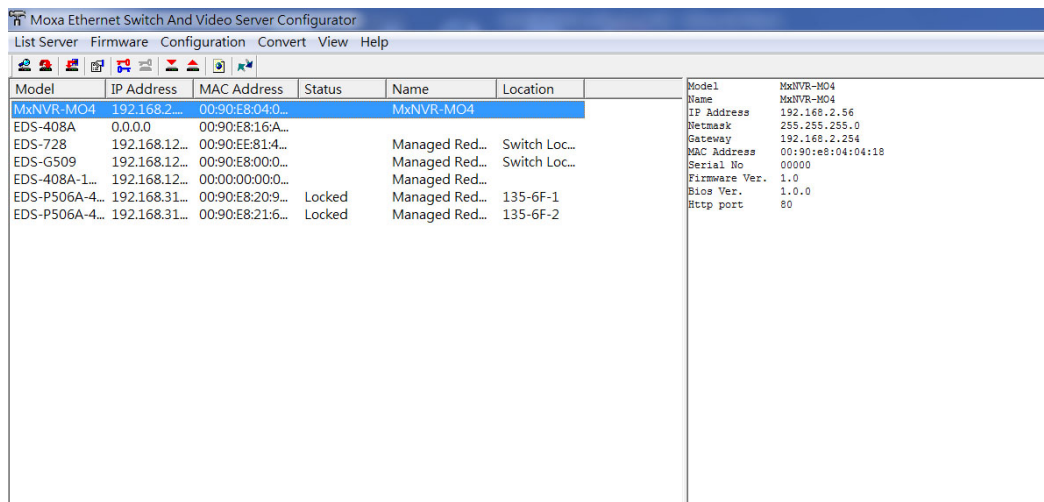

NOTE Broadcast Search can only be used to search for devices on the same LAN domain. If your devices are located on a different LAN domain, use Specify IP Address to search for the device by inputting the IP address.

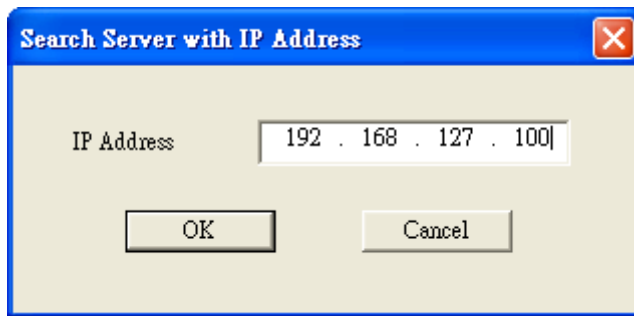

4. Use Internet Explorer to access the MxNVR-MO4's web-based manager (web console).

Network Environment without a DHCP Server:

If your MxNVR-MO4 is connected to a network that does not have a DHCP server, then you will need to configure the IP address manually. The default IP address of the MxNVR-MO4 is **192.168.127.100** and the default subnet mask is 255.255.255.0. Note that you may need to change your computer's IP address and subnet mask so that the computer is on the same subnet as the MxNVR-MO4.

To change the IP address of the MxNVR-MO4 manually, access the MxNVR-MO4's web server, and then navigate to the **System Configuration → Network → General page** to configure the IP address and other network settings. Check the **Use fixed IP address** box to ensure that the IP address you assign is not deleted each time the MxNVR-MO4 is restarted.

Step 6: Log into the ActiveX Control Plug-in

Type the IP address in the web browser's address input box and then press enter.

Step 7: Install the ActiveX Control plug-in

A security warning message will appear the first time you access the MxNVR-MO4's web-based manager. The message is related to installing the MxNVR-MO4 ActiveX Control component to your PC or notebook. Click on **Yes** to install this plug-in to enable the IE web browser for viewing video images.



NOTE For Windows XP SP2 or above operating systems, the ActiveX Control component will be blocked for system security reasons. In this case, the MxNVR-MO4's security warning message window may not appear. Users should unblock the ActiveX control function or disable the security configuration to enable the installation of MxNVR-MO4's ActiveX Control component.

Step 8: Accessing the homepage of the MxNVR-MO4's web-based manager.

After installing the ActiveX Control component, the homepage of the MxNVR-MO4's web-based manager will appear. Check the following items to make sure the system was installed properly:

1. Video Images
2. Audio (make sure your PC's or notebook's sound is turned on)
3. Video Information



Step 9: Accessing the MxNVR-MO4’s System Configuration

Click on System Configuration to access the overview of the system or to change the settings. Model Name, Server Name, IP Address, MAC Address, Firmware Version, and LED Status appear in the green bar near the top of the page. Use this information to check the system information and installation.

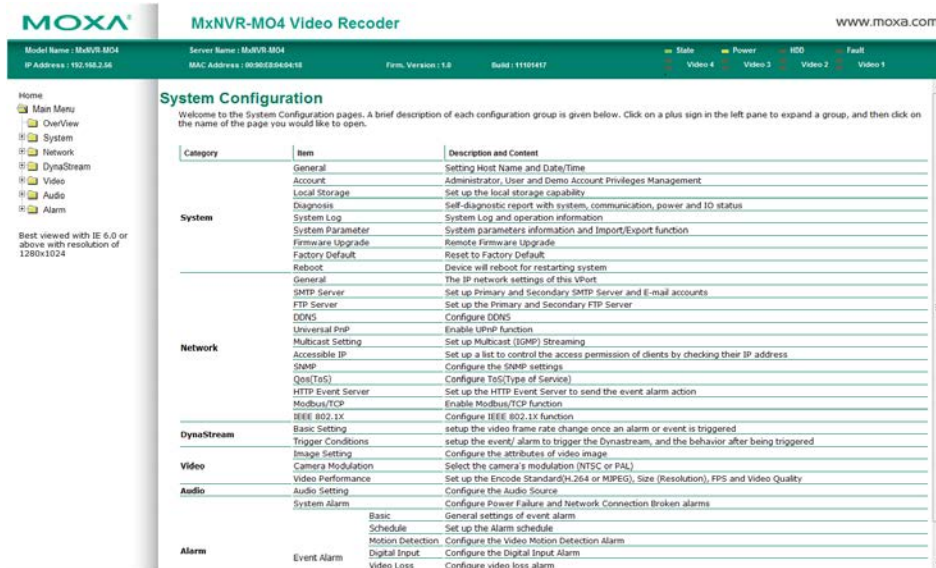

NOTE After accessing the MxNVR-MO4’s web-based manager, administrators should access **System Configuration** → **System** → **Account** to set up the administrator’s password and enable the authentication function. The administrator account name is **admin**.

An authentication window will pop up requesting the account name and password each time the MxNVR-MO4 is accessed.



RS-232 Console Configuration (115200, None, 8, 1, VT1 00)

NOTE

1. You **cannot** connect to the MxNVR-MO4 364 simultaneously by serial console and Telnet.
2. You **may** connect to the MxNVR-MO4 364 simultaneously by web browser and serial console, or by web browser and Telnet. However, we strongly recommend that you use only one connection method at a time. This allows you to maintain better control over your MxNVR-MO4 364's configuration.

You can access the RS-232 console by using a terminal emulator on your PC. We recommend that you use the PComm Terminal Emulator, which is free and can be downloaded from Moxa's website. The following instructions explain how to use PComm to access the RS-232 console.

1. Use an RJ45 to DB9-F (or RJ45 to DB25-F) cable to connect the MxNVR-MO4's RS-232 console port to a COM port on your PC.
2. From the Windows desktop, click **Start → Programs → PCommLite2.5 → Terminal Emulator**.

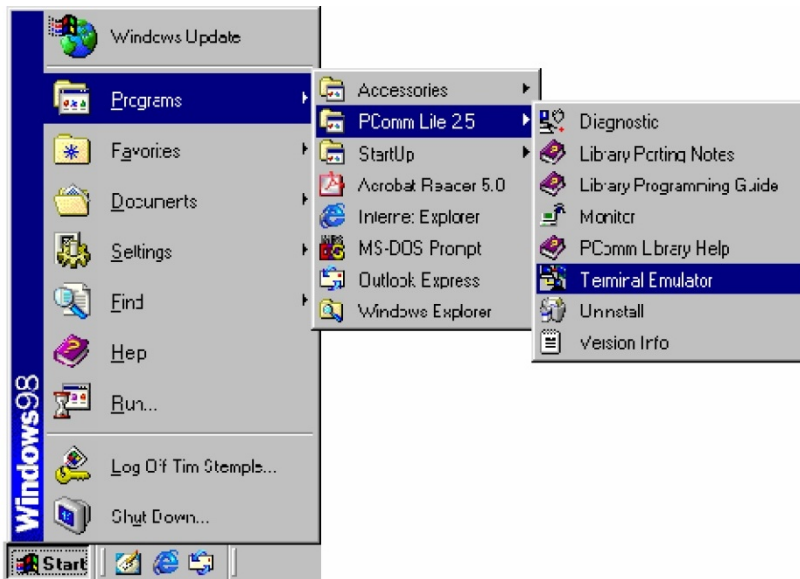

3. Select **Open** under **Port Manager** to open a new connection.

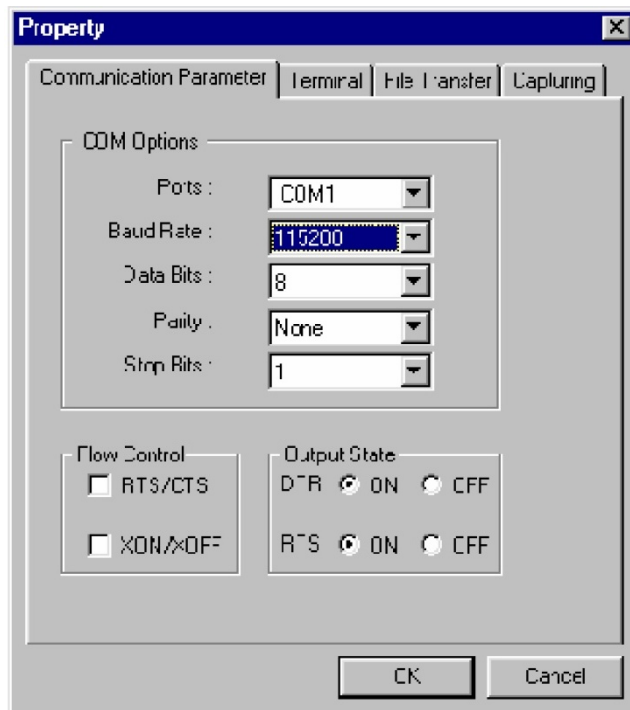

- The **Communication Parameter** page of the **Property** window opens. Select the appropriate COM port for **Console Connection**, **115200** for **Baud Rate**, **8** for **Data Bits**, **None** for **Parity**, and **1** for **Stop Bits**.

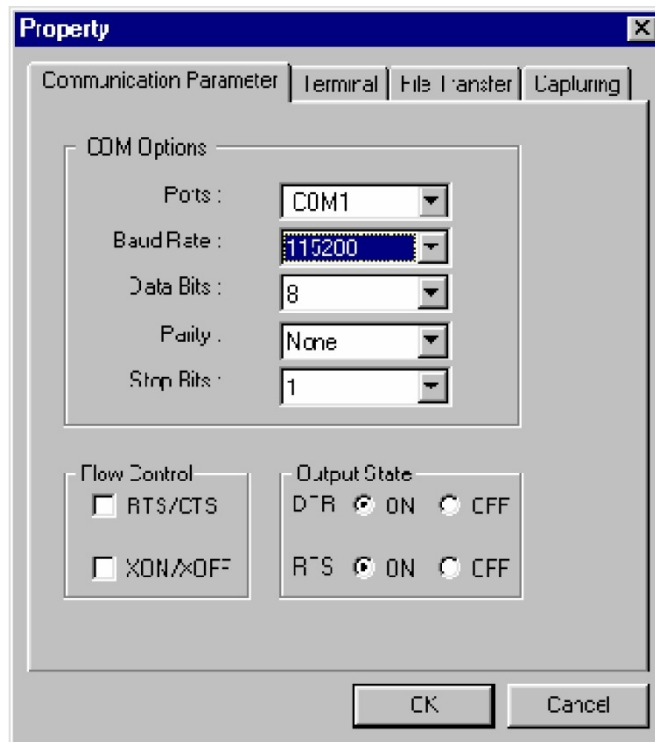

- Click the **Terminal** tab, and select **VT100** for **Terminal Type**. Click **OK** to continue.

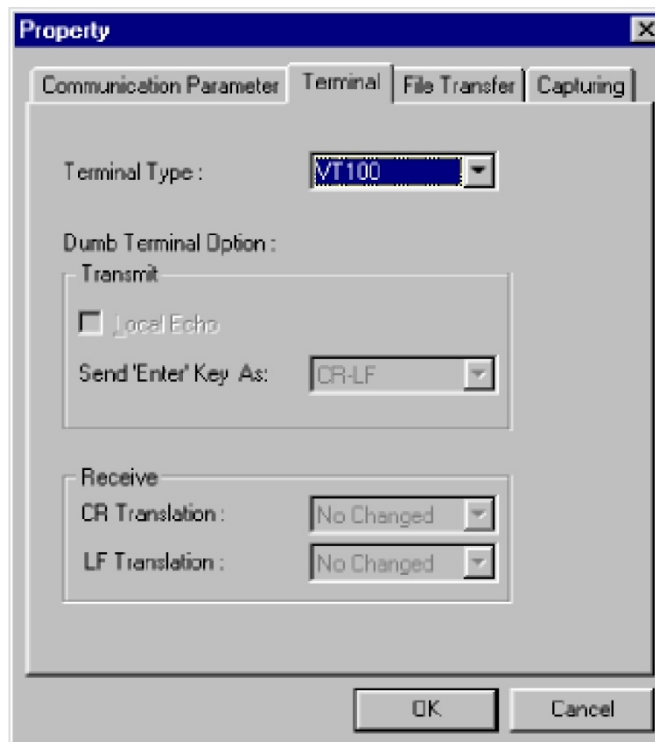

A blank screen will appear. Press Enter, after which a login message will appear. Only the administrator is allowed to use this console configuration. Use admin as the username and the associated admin password as the password. Press Enter to continue.

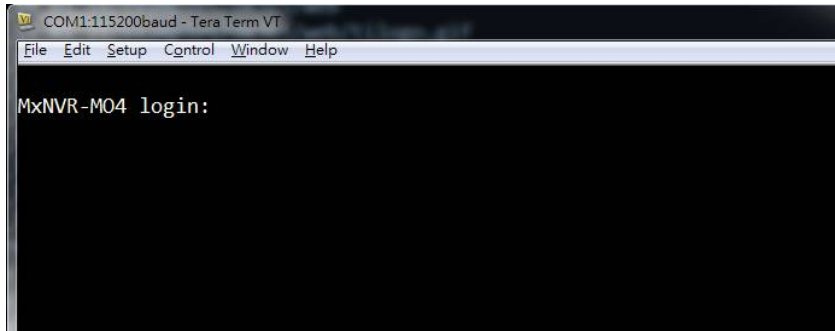

- The RS-232 console's **Main Menu** will be displayed.
(NOTE: To modify the appearance of the PComm Terminal Emulator window, select Font... under the Edit menu, and then choose the desired formatting options.)

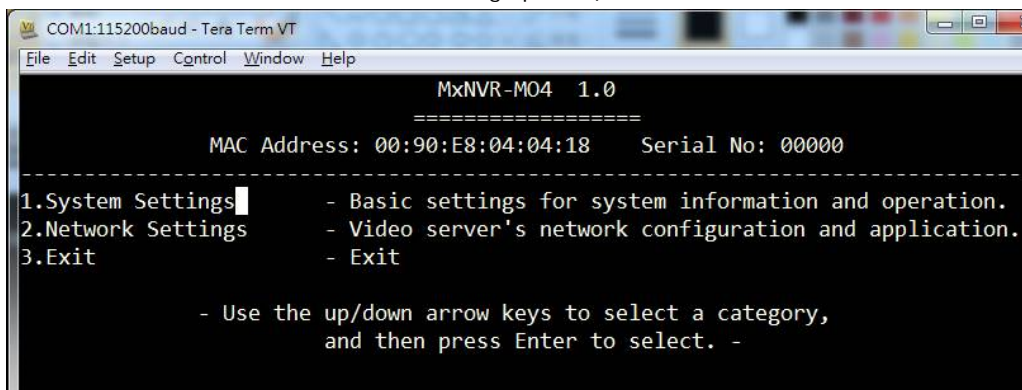

- After entering the **Main Menu**, use the following keys to move the cursor, and to select options.

Key	Function
Up/Down/Left/Right arrows, or Tab	Move the onscreen cursor
Enter	Display & select options
Space	Toggle options
Esc	Previous Menu

NOTE Many settings are related to video images, which cannot be shown on the RS-232 console. The MxNVR-MO4's RS-232 console only accesses the Basic System Settings and Network Settings. For more advanced configuration, please use the web console.

Mounting the MxNVR-MO4 Dimension

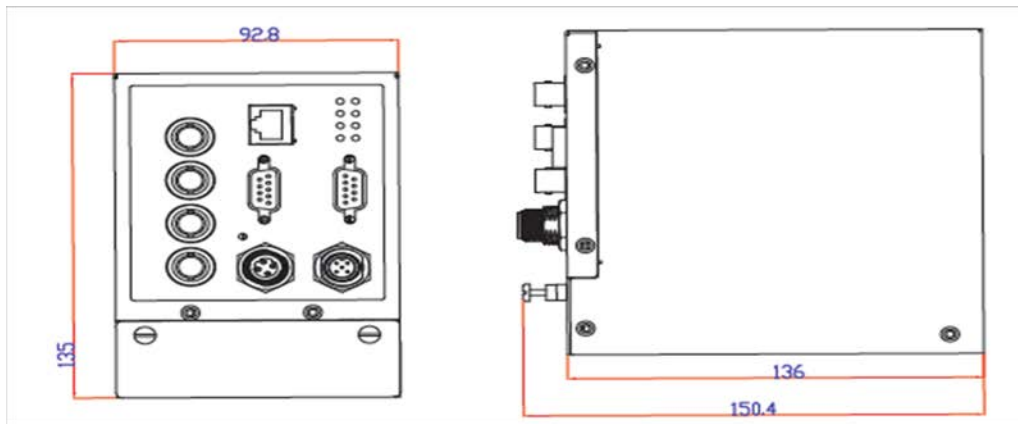

Front View

Side View

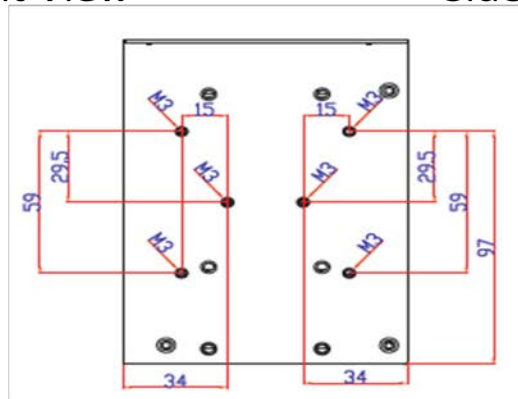

Back View

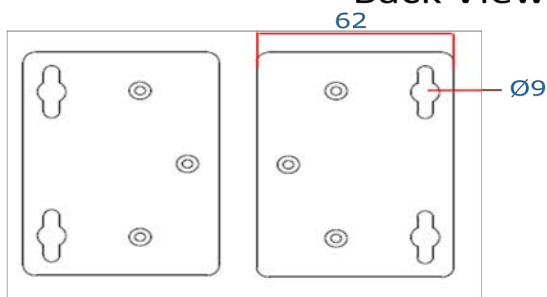

Panel Mounting kit

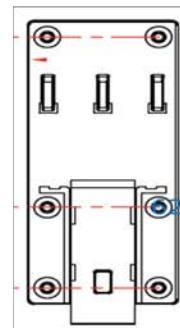

DIN-Rail Mounting kit

(Unit=mm)

Panel Mounting

For some applications, you will find it convenient to mount the MxNVR-MO4 on a wall, as illustrated below.

STEP 1:

Attach the panel mount plates, as shown in the diagrams below.

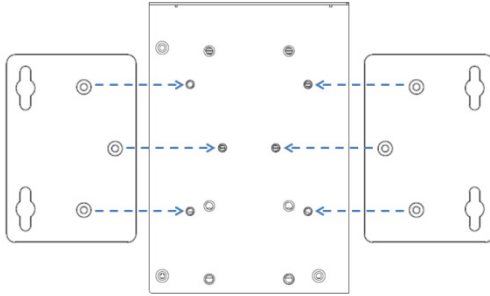

STEP 2:

Mounting MxNVR-MO4 on the wall requires 4 screws. Use the MxNVR-MO4, with panel mount plates attached, as a guide to mark the correct locations of the 4 screws. The heads of the screws should be less than 9.0 mm in diameter, and the shafts should be less than 5.0 mm in diameter, as shown in the figure at the right.

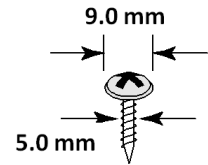

Do not screw the screws in all the way—leave a space of about 2 mm to allow room for sliding the wall mount panel between the wall and the screws.

NOTE Test the screw head and shank size by inserting the screw into one of the keyhole shaped apertures of the wall mounting plates, before it is screwed into the wall.

STEP 3:

Once the screws are fixed in the wall, insert the four screw heads through the large parts of the keyhole-shaped apertures, and then slide the MxNVR-MO4 downwards, as indicated below. Tighten the four screws for added stability.

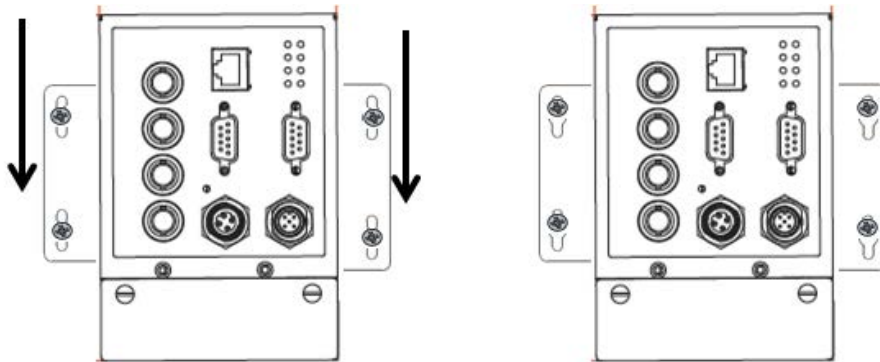

DIN-Rail mounting (with optional Kit)

You can mount the MxNVR-MO4 on a 35 mm DIN-Rail with the optional DK-DC50131 DIN-Rail mounting kit (must be purchased separately).

STEP 1:

Use 6 screws to attach the DIN-Rail attachment plates to the rear panel of the MxNVR.

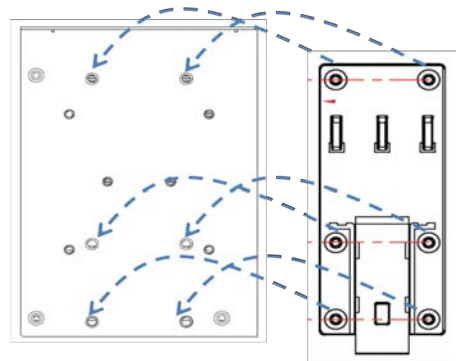

STEP 2:

If the spring-loaded bracket is locked in place, push the recessed button to release it. Once released, you should feel some resistance from the spring as you slide the bracket up and down a few millimeters in each direction.

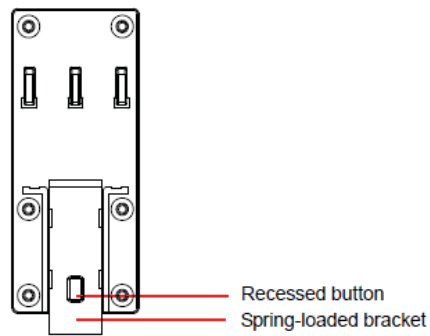

STEP 3:

Position the MxNVR on the DIN-Rail, tilting the switch to hook the clamps over the top edge of the rail.

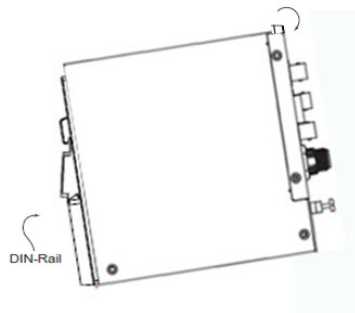

STEP 4:

Swing the switch into a vertical position until both clamps latch completely to the DIN-Rail,.

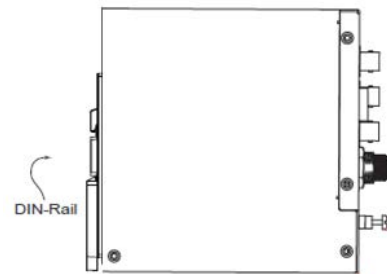

To remove the MxNVR-MO4 from the DIN-Rail, use a screwdriver to pull out the two spring-loaded brackets from the bottom until they are fixed in the "locked" position. Next, reverse Steps 3 and 4 above.

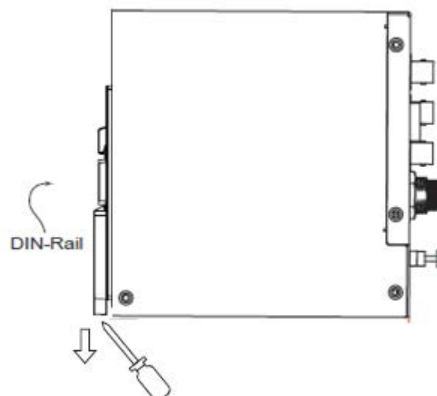

Wiring Requirements



ATTENTION

Be sure to disconnect the power cord before installing and/or wiring your Moxa MxNVR-MO4. Calculate the maximum possible current in each power wire and common wire. Observe all electrical codes dictating the maximum current allowable for each wire size. If the current goes above the maximum ratings, the wiring could overheat, causing serious damage to your equipment.

You should also pay attention to the following:

- Use separate paths to route wiring for power and devices. If power wiring and device wiring paths must cross make sure the wires are perpendicular at the intersection point.
NOTE: Do not run signal or communications wiring and power wiring in the same wire conduit. To avoid interference, wires with different signal characteristics should be routed separately.
- You can use the type of signal transmitted through a wire to determine which wires should be kept separate. The rule of thumb is that wiring that shares similar electrical characteristics can be bundled together.
- Keep input wiring and output wiring separated.
- It is strongly advised that you label wiring to all devices in the system when necessary.

Grounding the MxNVR-MO4

Grounding and wire routing help limit the effects of noise due to electromagnetic interference (EMI). Run the ground connection from the ground screw to the grounding surface prior to connecting devices.



ATTENTION

This product is intended to be mounted to a well-grounded mounting surface, such as a metal panel.

Accessing the MxNVR-MO4's Web-based Manager

This chapter includes information about how to access the MxNVR-MO4 364 Video Recorder for the first time.

The following topics are covered in this chapter:

❑ Functions Featured on the MxNVR-MO4's Web Homepage

- MxNVR's Information
- Server Name
- Camera Image View
- Client Settings
- System Configuration
- Video Information
- Snapshot
- Relay Control

❑ Video Recording with the MxNVR-MO4

- ❑ Retrieve the Recorded Video from MxNVR-MO4**
- ❑ Stop the Video Recording**
- ❑ Status of the hard disk**

Functions Featured on the MxNVR-MO4's Web Homepage

The homepage of the MxNVR-MO4's web console shows information specific to that MxNVR-MO4, the camera image, and configurations for the client and server.

NOTE The MxNVR-MO4's web homepage is best viewed in 1280 x 1024 screen resolution. This is because the camera image can be viewed at a resolution up to Full D1 (NTSC: 720 x 480; 720 x 576). We strongly recommend using IE 6.0 (Microsoft Internet Explorer) or above to avoid incompatibility with the ActiveX Plug-in.



MxNVR's Information

This section shows the MxNVR-MO4's model name, server name, IP address, MAC address, firmware version, and the display status of the LEDs located on the MxNVR-MO4's front panel.

NOTE The MxNVR-MO4 LEDs shown on the MxNVR-MO4's web homepage are updated every 10 seconds.

Server Name

A server name can be assigned to each server. Administrators can change the name in **System Configuration/System/General**. The maximum length of the server name is 40 bytes.

Camera Image View

The assigned image description and system date/time will be displayed in the caption above the image window. You may disable the caption or change the location of the image information in **System Configuration/Video/Image Setting**. Note that if the MxNVR-MO4's motion detection function is active, some windows in the video picture might be framed in red.

Client Settings

Users can configure the following functions in Client Settings.

1. Encode standard: Shows the encoding algorithm currently being used. MxNVR-MO4 features built-in 2 encode engines to generate dual simultaneous video streams. Each client can select the H.264 video streams from Stream 1, or the MJPEG video stream from Stream 2. To configure these video streams, please go to System Configuration → Video → Video Performance.
2. Media Options: Enable or disable the video or audio transmission.
3. Protocol Options: Choose one of four protocols to optimize your usage—Multicast (RTSP or Push) or Unicast (UDP, TCP, HTTP).
 - **Multicast** protocol can be used to send a single video stream to multiple clients. In this case, a lot of bandwidth can be saved since only one video stream is transmitted over the network. However, the network gateway (e.g., a switch) must support the multicast protocol (e.g., IGMP snooping). Otherwise, the multicast video transmission will not be successful.
 - **RTSP**: Enable the multicast video stream to be sent in RTSP control, which means the multicast video stream will be sent only it receives the client's request.
 - **Push**: Enable the multicast video stream to be sent in Push control, which means that after this setting is selected the multicast video stream will be sent continuously even without any client request.
 - **Unicast** protocol is used to send a single video stream to one client.
 - **UDP** can be used to produce audio and video streams that are more real-time. However, some packets may be lost due to network burst traffic, and images may become blurred
 - **TCP** can be used to prevent packet loss, which results in a more accurate video display. The downside of using TCP is that the real-time delay is worse than with UDP protocol.
 - **HTTP** can be used to prevent being blocked by a router's firewall. The downside of using HTTP is that the real-time delay is worse than with UDP protocol.

Once the video recorder is connected successfully, Protocol Options will indicate the selected protocol. The selected protocol will be stored on the user's PC, and will be used for the next connection.
4. Network interface: choose the IP address for the NIC card being used.

NOTE For multicast video stream settings, please refer to **System Configuration → Network → Multicast**.

Client Setting

Channel 1	Channel 2
Encode Standard <input checked="" type="radio"/> H.264 <input type="radio"/> Motion JPEG	Encode Standard <input checked="" type="radio"/> H.264 <input type="radio"/> Motion JPEG
Media Option <input checked="" type="radio"/> Video/Audio <input type="radio"/> Video Only <input type="radio"/> Audio Only	Media Option <input checked="" type="radio"/> Video/Audio <input type="radio"/> Video Only <input type="radio"/> Audio Only
Protocol Option <input type="radio"/> Multicast <input checked="" type="radio"/> RTSP <input type="radio"/> Unicast <input type="radio"/> TCP	Protocol Option <input type="radio"/> Multicast <input checked="" type="radio"/> RTSP <input type="radio"/> Unicast <input type="radio"/> TCP
Channel 3	Channel 4
Encode Standard <input checked="" type="radio"/> H.264 <input type="radio"/> Motion JPEG	Encode Standard <input checked="" type="radio"/> H.264 <input type="radio"/> Motion JPEG
Media Option <input checked="" type="radio"/> Video/Audio <input type="radio"/> Video Only <input type="radio"/> Audio Only	Media Option <input checked="" type="radio"/> Video/Audio <input type="radio"/> Video Only <input type="radio"/> Audio Only
Protocol Option <input type="radio"/> Multicast <input checked="" type="radio"/> RTSP <input type="radio"/> Unicast <input type="radio"/> TCP	Protocol Option <input type="radio"/> Multicast <input checked="" type="radio"/> RTSP <input type="radio"/> Unicast <input type="radio"/> TCP
Network Interface: 192.168.127.7	
<input type="button" value="Save"/>	

System Configuration

A button or text link on the left side of the system configuration window only appears on the administrator's main page. For detailed system configuration instructions, refer to Chapter 5, **System Configuration**.

Video Information

Users can easily monitor the current video performance by looking at the **Video Information** shown on the left side of the homepage. The following properties are shown: Video Size, Video Quality (Fixed bit rate or Fixed video quality), Max. FPS (frames per second), and (current) FPS Status. Users can select the target camera image to view each camera's video performance.

Snapshot

Users can take snapshot images for storing, printing, or editing by clicking the **Channel 1, 2, 3, and 4** buttons. To save the image, right-click and select the **Save** option.

Relay Control

The MxNVR-MO4 has 1 relay outputs for external devices, such as alarms. Administrators and permitted users can click on **Open** to short the **Common** and **Normal Open** digital output pins, or click on **Close** to short the **Common** and **Normal Close** digital output pins.

Video Recording with the MxNVR-MO4

MxNVR-MO4 includes 1 SATA connection for local video recording to a HDD (hard disk) or SSD (Solid State Disk). To record video, there are some steps to perform after the HDD or SSD is mounted successfully (please refer chapter 2 for the HDD installation).

Step 1: Initialize the HDD or SSD

Click the **Start** button to initialize the HDD or SSD in the **System Configuration -> System -> Local Storage** configuration page. The initialize HDD process is complete once the "Format Finished.....Rebooting" message is displayed.



After the initialization, the HDD or SDD will be separated into 10 folders, each of which is granted about 10% of the total storage space. Once the spare storage space in a folder is under 100 MB, the video will be recorded into the next folder.

NOTE MxNVR-MO4 uses the First-in-first-out recycling storage. Once these 10 folders are out of storage space, the oldest recorded video in the first folder will be deleted to store newly recorded video.

Step 2: Configure the Video Recording mode, channel, stream, and schedule

Configure the recording mode: event/alarm or scheduled recording, the recording channel/stream, and the recording schedule in the **System Configuration -> System -> Local Storage** configuration page.

Local Video Recording Mode

Disable
 Event/Alarm Record
 Schedule Record

Record Stream

CH1: Disable Stream1: H.264 Stream2: MJPEG
 CH2: Disable Stream1: H.264 Stream2: MJPEG
 CH3: Disable Stream1: H.264 Stream2: MJPEG
 CH4: Disable Stream1: H.264 Stream2: MJPEG

Record Schedule

All the Time Schedule Record

Start Time 08:00 End Time 08:00

SUN MON TUE WEN THU FRI SAT

Step 3: Click on SAVE, and then MxNVR-MO4 will start to run the video recording.

The administrator also can use the CGI command:

http://ip/moxa-cgi/setparam.cgi?localstorage_recordmode=1 or 2 (1 means enable the video record by event, 2 means enable the video record by schedule) to enable the video recording function.

NOTE The video recording will keep running based on the configuration whenever the MxNVR-MO4 is power off and then power on.

Retrieve the Recorded Video from MxNVR-MO4

To retrieve the recorded video from MxNVR-MO4, it is required to use the FTP download method.

Step 1: Setup the FTP server daemon

The administrator needs to enable the FTP server daemon in the **System Configuration** → **System** → **Local Storage** configuration page to download video from the MxNVR-MO4.

FTP Server Daemon

Enable FTP Server Daemon

Server Port 21

Step 2: Access into MxNVR-MO4's FTP server

The administrator can access into MxNVR-MO4's FTP server via a web browser or a FTP software. The account name is **admin** and the password is as same as the admin's password. In the FTP server, there are 10 folders: part01, part02...part10. Each folder will have sub-folders to categorize the recorded videos by year, month, date, hour, channel number (ch01, ch02, ch03 and ch04) and video.

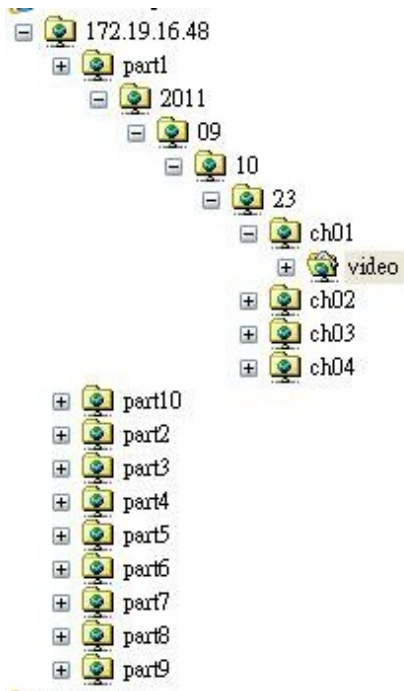

NOTE There is only one administrator account allowed to access into the MxNVR-MO4.

Step 3: Download the recorded videos

The administrator can select the recorded videos for download. The file name of these recorded video is Ch0x_YYYYMMDD_HHMMSS.avi.

- Ch0x: Indicates ch01, ch02, ch03 and ch04
- YYYYMMDD: Indicates the year, month, and day.
- HHMMSS: Indicates the hour, minute and second.

Each recorded video file contains 1 minute of video in AVI format, which can be played by popular media players.

ch01_20110910_230335.avi	843 KB	VLC media file (.avi)	2011/9/10 下午 11:04
ch01_20110910_230437.avi	835 KB	VLC media file (.avi)	2011/9/10 下午 11:05
ch01_20110910_230537.avi	835 KB	VLC media file (.avi)	2011/9/10 下午 11:06
ch01_20110910_230637.avi	835 KB	VLC media file (.avi)	2011/9/10 下午 11:07
ch01_20110910_230737.avi	837 KB	VLC media file (.avi)	2011/9/10 下午 11:08
ch01_20110910_230837.avi	837 KB	VLC media file (.avi)	2011/9/10 下午 11:09
ch01_20110910_230936.avi	836 KB	VLC media file (.avi)	2011/9/10 下午 11:10
ch01_20110910_231036.avi	837 KB	VLC media file (.avi)	2011/9/10 下午 11:11
ch01_20110910_231136.avi	836 KB	VLC media file (.avi)	2011/9/10 下午 11:12
ch01_20110910_231236.avi	835 KB	VLC media file (.avi)	2011/9/10 下午 11:13
ch01_20110910_231337.avi	835 KB	VLC media file (.avi)	2011/9/10 下午 11:14
ch01_20110910_231437.avi	836 KB	VLC media file (.avi)	2011/9/10 下午 11:15
ch01_20110910_231537.avi	835 KB	VLC media file (.avi)	2011/9/10 下午 11:16
ch01_20110910_231637.avi	835 KB	VLC media file (.avi)	2011/9/10 下午 11:17
ch01_20110910_231737.avi	835 KB	VLC media file (.avi)	2011/9/10 下午 11:18
ch01_20110910_231837.avi	110 KB	VLC media file (.avi)	2011/9/10 下午 11:18

Stop the Video Recording

To stop the video recording, the administrator can change the recording mode to Disable in the **System Configuration** → **System** → **Local Storage** configuration page, or send a CGI command:

http://ip/moxa-cgi/setparam.cgi?localstorage_recordmode=0

**ATTENTION**

Before powering off the MxNVR-MO4, the video recording must be stopped and the hard disk must be uninstalled, or the video file in recording will be crushed due to the uncompleted storage process. At this time, a CGI command: <http://IP/moxa-cgi/stoprecord.cgi> must be used.

Status of the hard disk

MxNVR-MO4 can report the status of HDD by getting the HDD's SMART command (the HDD must support SMART commands) every 10 minutes. A CGI command: <http://ip/moxa-cgi/getiostatus.cgi> is used for this purpose.

The reply message is like SYS=2 PW1=1 FAULT=0 VIDEO1=1 VIDEO2=1 VIDEO3=1 VIDEO4=1 DI1=0 DI2=0 DI3=0 DI4=0 DO1=1 RECVIDEO1=1 RECVIDEO2=1 RECVIDEO3=1 RECVIDEO4=1 HDDEXIST=1 HDDISMOUNT=1 HDDSMARTSTATUS=PASSED

- **HDDEXIST:** =1 indicates that the HDD is detected; =0 indicates that the HDD is not detected
- **HDDISMOUNT:** =1 indicates that the HDD is mounted successfully, =0 indicates that the HDD is not mounted successfully
- **HDDSMARTSTATUS:** =Passed indicates that the SMART command reports the HDD is functioning normally, =Failed indicates that the SMART command reports that the HDD is not functioning normally

NOTE The CGI command <http://ip/moxa-cgi/smartstatus.cgi> can get the hard disk return information, which is featured with the SMART commands support. This CGI command will be provided after firmware version V1.1.

System Configuration

After installing the hardware, the next step is to configure the MxNVR-MO4 364's settings. Users can configure by web console.

The following topics are covered in this chapter:

▣ **System Configuration by Web Console**

- System
- Network
- DynaStream™
- Video
- Audio
- Alarm

System Configuration by Web Console

System configuration can be done remotely with Internet Explorer. To access the server, type the system configuration URL, **http://<IP address of Video Server>overview.asp**, to open the configuration main page.

There are six configuration categories: **System, Network, Video, Serial Port, Audio, and Alarm**. A description of each configuration item is shown in the table below:

Category	Item	Description and Contents	
System	General	Set Host Name and Date/Time	
	Accounts	Administrator, User, and Demo Account Privileges Management	
	Local storage	Set up the local storage capability	
	Diagnosis	Self-diagnostic report with system, communication, power, and LED status	
	System Log	System Log and operation information	
	System Parameter	System parameter information and Import/Export functions	
	Firmware Upgrade	Remote Firmware Upgrade	
	Factory Default	Reset to Factory Default	
	Reboot	Device will reboot for restarting system	
Network	General	The IP network settings of this MxNVR-MO4	
	SMTP Server	Set up Primary and Secondary SMTP Server and e-mail accounts	
	FTP Server	Set up the Primary and Secondary FTP Server	
	DDNS	Configure Dynamic DNS service	
	Universal PnP	Enable UPnP function	
	Multicast Setting	Set up Multicast (IGMP) Streaming	
	Accessible IP	Set up a list to control the access permission of clients by IP address	
	SNMP	Configure the SNMP settings	
	QoS (ToS)	Configure ToS(Type of Service)	
	HTTP Event Server	Set up the HTTP Event Server to send the event alarm action	
	Modbus/ TCP	Enable Modbus/TCP function	
DynaStream™	Basic Setting	Setup the video frame rates for alarm or event triggers	
	Trigger Condition	Setup the event or alarm conditions that trigger Dynastream™ as well as the desired actions that follow.	
Video	Image Settings	Configure the attributes of the video image	
	Camera Modulation	Select the camera's modulation (NTSC, PAL or AUTO)	
	Video Performance	Configure the Size (Resolution), FPS, and Video Quality	
Audio	Audio Settings	Set up the audio source	
Alarm	System Alarm	Configure Power Failure and Network Connection Broken alarms	
	Event Alarm	Basic	General event alarm settings
		Schedule	Set up the Alarm schedule
		Motion Detection	Configure the video motion detection alarm.
		Digital Input	Configure the Digital Input alarm
		Video Loss	Configure the video loss alarm
		CGI Event	Set up the CGI event alarm
		Sequential Snapshot	Set up the Sequential Snapshot operation

This table can also be found on the **System Configuration → Overview webpage**.

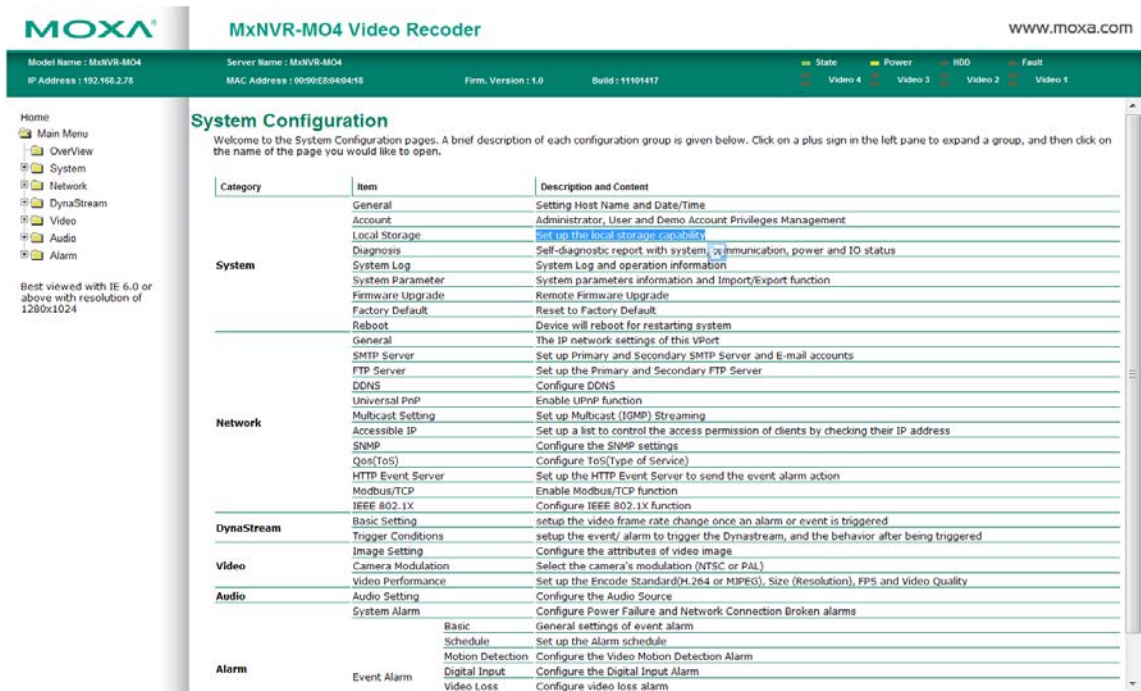

System

General Settings

On the **General Settings** page, administrators can set up the video **Server name** and the **Date and Time**, which is displayed in the image's caption.

General Settings

Server name :

Date and Time:

Keep current date and time

Sync with computer time

PC date: [yyyy/mm/dd]

PC time: [hh:mm:ss]

Manual

Date: [yyyy/mm/dd]

Time: [hh:mm:ss]

Automatic

1st NTP server:

2nd NTP server:

Time zone:

Update interval:

Server name

Setting	Description	Default
Max. 40 characters	Use a different server name for each server to help identify the different servers. The name appears on the web homepage.	MxNVR-MO4

Date and Time

Setting	Description	Default
Keep current date and time	Use the current date and time as the MxNVR-MO4's time setting.	Keep current date and time
Sync with computer time	Synchronize MxNVR-MO4's data and time setting with the local computer time.	
Manual	Manually change MxNVR-MO4's date and time setting.	
Automatic	Use the NTP server for changing MxNVR-MO4's date and time setting in a given period. There are 2 NTP servers. The 2nd server is the backup for when the 1st NTP server cannot be accessed.	

NOTE Select the Automatic option to force the MxNVR-MO4 to synchronize automatically with timeservers over the Internet. However, synchronization may fail if the assigned NTP server cannot be reached, or the MxNVR-MO4 is connected to a local network. Leaving the NTP server blank will force the MxNVR-MO4 to connect to default timeservers. Enter either the Domain name or IP address format of the timeserver if the DNS server is available.
 Don't forget to set the Time zone for local settings. Refer to Appendix for your region's time zone.

Account Privileges

Different account privileges are available for different purposes.

Account Privileges

Admin Password

Admin Password:

Confirm Password:

Note: Admin's password must be blank or 8 to 15 characters. If leave admin password blank will disable user authentication.

User's Privileges

No.	User Name	Password	Privileges
1	<input type="text"/>	<input type="password"/>	<input type="checkbox"/> Control RELAY1
2	<input type="text"/>	<input type="password"/>	<input type="checkbox"/> Control RELAY1
3	<input type="text"/>	<input type="password"/>	<input type="checkbox"/> Control RELAY1
4	<input type="text"/>	<input type="password"/>	<input type="checkbox"/> Control RELAY1
5	<input type="text"/>	<input type="password"/>	<input type="checkbox"/> Control RELAY1
6	<input type="text"/>	<input type="password"/>	<input type="checkbox"/> Control RELAY1
7	<input type="text"/>	<input type="password"/>	<input type="checkbox"/> Control RELAY1
8	<input type="text"/>	<input type="password"/>	<input type="checkbox"/> Control RELAY1
9	<input type="text"/>	<input type="password"/>	<input type="checkbox"/> Control RELAY1
10	<input type="text"/>	<input type="password"/>	<input type="checkbox"/> Control RELAY1

Admin password

Setting	Description	Default
Admin Password (max. 5 characters)	The administrator can type the new password in this box.	Default admin password is "admin"
Confirm Password (max. 5 characters)	If a new password is typed in the Admin Password box, you will need to retype the password in the Confirm Password box before updating the new password.	

NOTE The default account name for administrator is admin; the administrator account name cannot be changed.

User's Privileges

MxNVR-MO4 products provide 10 user accounts for accessing the MxNVR-MO4. Administrators can set up user's privileges in this section. Each user can be given independent access rights to the external I/O and camera control.

Setting	Description	Default
User Name	Type a specific user name for user authentication.	None
Password	Type a specific password for user authentication.	
Privilege	Check the function boxes to assign privileges for users in Control Relay1	

NOTE The FPS of the video stream will be reduced as more and more users access the same MxNVR-MO4. Currently, the MxNVR-MO4 is only allowed to send 8 unicast video streams at the same time. Therefore, limit the number of users simultaneously accessing a MxNVR-MO4 to prevent performance problems.

Local Storage

The MxNVR-MO4 supports a local storage function for recording video onto a 2.5-inch HDD or SSD (solid state disk). Once this local storage is enabled, the MxNVR-MO4 will start to record the video based on the Video Record Mode or the Record Schedule.

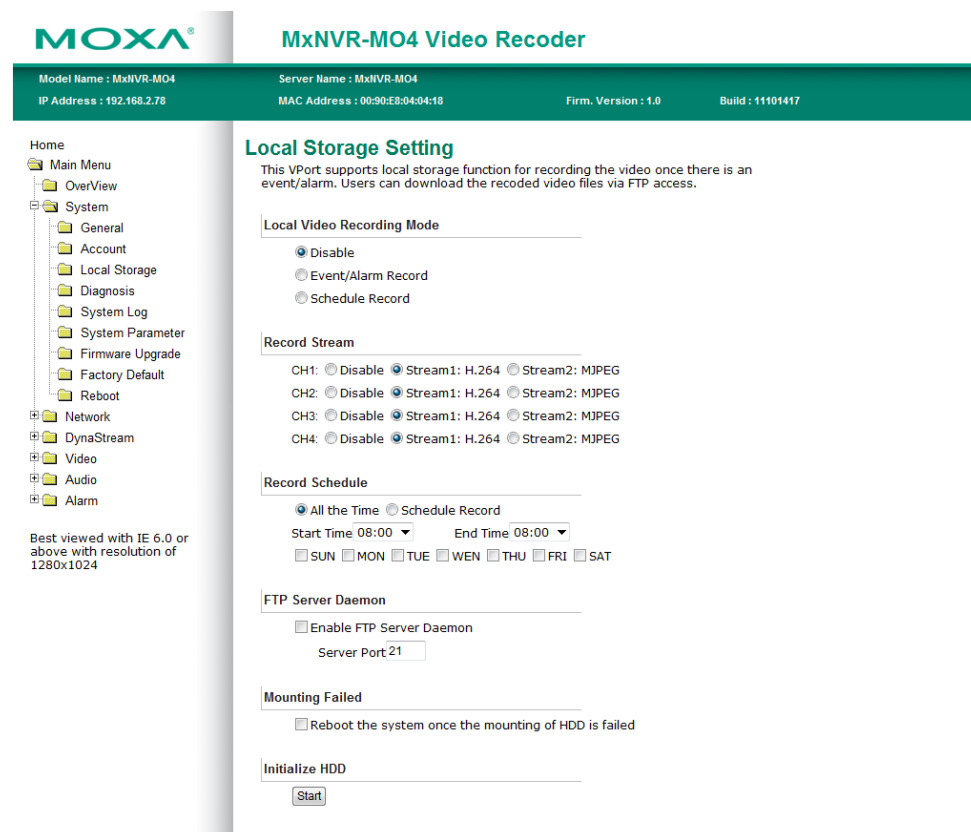

Local Video Recording mode

Setting	Description	Default
Disable	The video recording function is disable	Disable
Event/ Alarm Record	The video recording function activates when an event or alarm occurs. The administrator can set up the event or alarm in System Configuration→Alarm	
Schedule Record	The video recording action is activated based on the Record Schedule setting.	

Record Stream

Choose the video stream each video channel (ch1, ch2, ch3 and ch4) will record.

Setting	Description	Default
Disable	This video channel doesn't perform video recording.	Disable
Stream 1: H.264	This video channel records stream 1: H.264 video stream	
Stream 2: MJPEG	This video channel records stream 2: MJPEG video stream	

NOTE To change the video resolution, frame rate and video quality, please go to the **System Configuration → Video → Video performance** configuration page.

Record Schedule

Set up the video recording for **All the time** or **Schedule Record** behavior.

Setting	Description	Default
All the time	The video recording will be activated constantly when the MxNVR-MO4 is powered on.	All the time
Schedule record	The video recording will be activated based on the schedule setup.	
Start time	The time the video recording is activated.	8:00
End time	The time the video recording is ended.	8:00
SUN MON TUE WEN THU FRI SAT	Select the weekday the video recording is activated.	Blank

FTP Server Daemon

Set up the FTP server for remotely downloading the recorded video clips.

Setting	Description	Default
Enable FTP Server Daemon	Enable or disable the FTP server daemon for remote access	Disable
Server port	The access port of the FTP server	21

Mounting Failed

Sometimes there may be failure in mounting the HDD or SSD. If this occurs, the system needs to reboot to run the mounting process again.

Setting	Description	Default
Reboot the system once the mounting of HDD is failed.	Enable a automatic system reboot if the HDD is mounted and fails	Disable

Initialize HDD

Because the recording system structure of MxNVR-MO4 is proprietary, it is required to initialize a HDD or SDD which is mounted in the MxNVR-MO4 for the first time, whether it is a new HDD or a used HDD. Click the **Start** button and wait for few seconds, and then the MxNVR-MO4 will start to run the format process. The HDD initialization process is complete once the "**Format Finished.....Rebooting**" message displays.

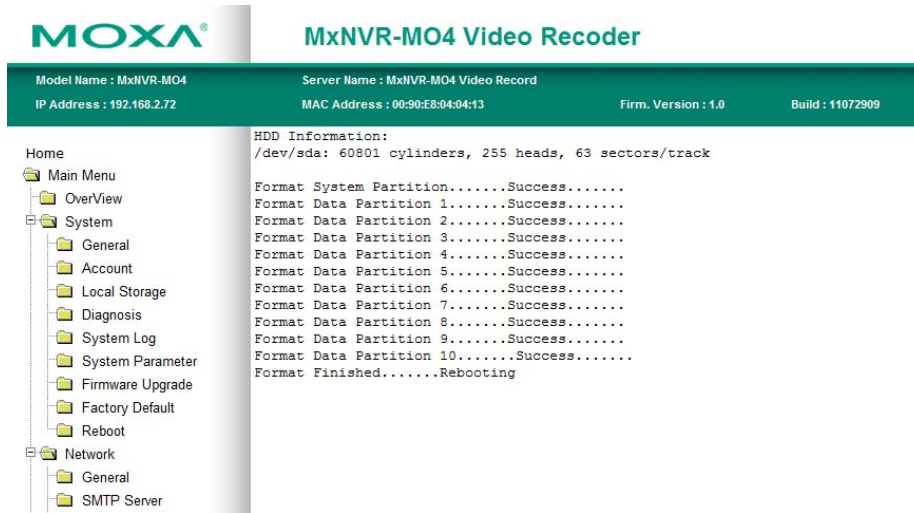

System Diagnosis

MxNVR-MO4 products have a self-diagnosis function to let the administrator get a quick view of the system and connection status. Administrators can save this diagnosis information in a file (diagnosis.log) by clicking the **Export to a File** button, or send the file via email by clicking the **Send a Report via Email** button.

System Diagnosis

System Status	
System	
Serve Name:MxNVR-MO4 Video Record	Firmware Version:1.0 Build 11101417
Date/Time: Keep current data and time	User Accounts:0
Network	
Access Method:Get IP address automatically	IP Address:192.168.2.72
Gateway:192.168.2.254	Subnet Mask:255.255.255.0
Primary DNS:192.168.50.33	Secondary DNS:192.168.1.97
HTTP Port:80	RTSP Port:554
Unicast Access Name:udpstream	Multicast Access Name:multicaststream
HTTP Access Name:moxa-cgi/udpstream	
1st SMTP Server:Disable	2nd SMTP Server:Disable
1st Recipient Email Address:	2nd Recipient Email Address:
1st Sender Email Address:	2nd Sender Email Address:
1st FTP Server:Disable	2nd FTP Server:Disable
1st FTP Passive Mode:Disable	2nd FTP Passive Mode:Disable
Accessible IP List:Disable	UPnP:Enable
SNMP Version:V1, V2c, V3	Admin Auth. Type:No-Auth
ToS:Disable	DSCP Value:00
DDNS:Disable	Modbus/TCP:Enable
1st Channel Multicast	
Multicast Address:239.127.0.100	Multicast TTL:128
Multicast video port:5556	Multicast audio port:5558
Auto Multicast:Disable	
2nd Channel Multicast	
Multicast Address:239.127.0.100	Multicast TTL:128
Multicast video port:5560	Multicast audio port:5562
Auto Multicast:Disable	
3rd Channel Multicast	
Multicast Address:239.127.0.100	Multicast TTL:128
Multicast video port:5564	
Auto Multicast:Disable	
4th Channel Multicast	

System Log History

The system log contains useful information, including current system configuration and activity history with timestamps for tracking. Administrators can save this information in a file (system.log) by clicking the **Export to a File** button, or send the file by email by clicking the **Send a Report via Email** button. In addition, the log can also be sent to a **Log Server** for backup. The administrator can set up the Syslog Server 1 and Syslog server 2 below the system log list.

System Log History

Index	Time	Type	Description
0001	Wed Nov 11 10:35:56 2009	FTP	Connect to Server 192.168.127.9:21 Failed
0002	Wed Nov 11 10:35:57 2009	FTP	Connect to Server 192.168.127.9:21 Failed
0003	Wed Nov 11 10:35:58 2009	FTP	Connect to Server 192.168.127.9:21 Failed
0004	Wed Nov 11 10:35:59 2009	FTP	Connect to Server 192.168.127.9:21 Failed
0005	Wed Nov 11 10:36:00 2009	FTP	Connect to Server 192.168.127.9:21 Failed
0006	Wed Nov 11 10:36:01 2009	FTP	Connect to Server 192.168.127.9:21 Failed
0007	Wed Nov 11 10:36:02 2009	FTP	Connect to Server 192.168.127.9:21 Failed
0008	Wed Nov 11 10:36:03 2009	FTP	Connect to Server 192.168.127.9:21 Failed
0009	Wed Nov 11 10:36:04 2009	FTP	Connect to Server 192.168.127.9:21 Failed
0010	Wed Nov 11 10:36:05 2009	FTP	Connect to Server 192.168.127.9:21 Failed
0011	Wed Nov 11 10:36:06 2009	FTP	Connect to Server 192.168.127.9:21 Failed
0012	Wed Nov 11 10:36:07 2009	FTP	Connect to Server 192.168.127.9:21 Failed

Export to a File Send a Report via E-mail Clear

Send to system log Server

Syslog Server 1

Port Destination

Syslog Server 2

Port Destination

Send to system log server

Setting	Description	Default
Send to system log server	Enables sending the system log to the log sever.	Disable
Syslog Sever 1	The address of the first system log server.	Blank
Port Destination	The port number of first system log server.	514
Syslog Sever 2	The address of the second system log server.	Blank
Port Destination	The port number of second system log server.	514

NOTE A maximum of 500 lines is displayed in the log. Earlier data beyond the first 500 entries are still in the MxNVR-MO4's database; the administrator can export them at any time.

System Parameters

The **System Parameters** page allows you to view all system parameters, which are listed by category. The content is the same as the MxNVR-MO4's sys_config.ini file. Administrators can also save this information in a file (sys_config.ini) by clicking the **Export to a File** button, or import a file by clicking the **Browse** button to search for a sys_config.ini file and then clicking the **Import a System Parameter File** button to update the system configuration quickly.

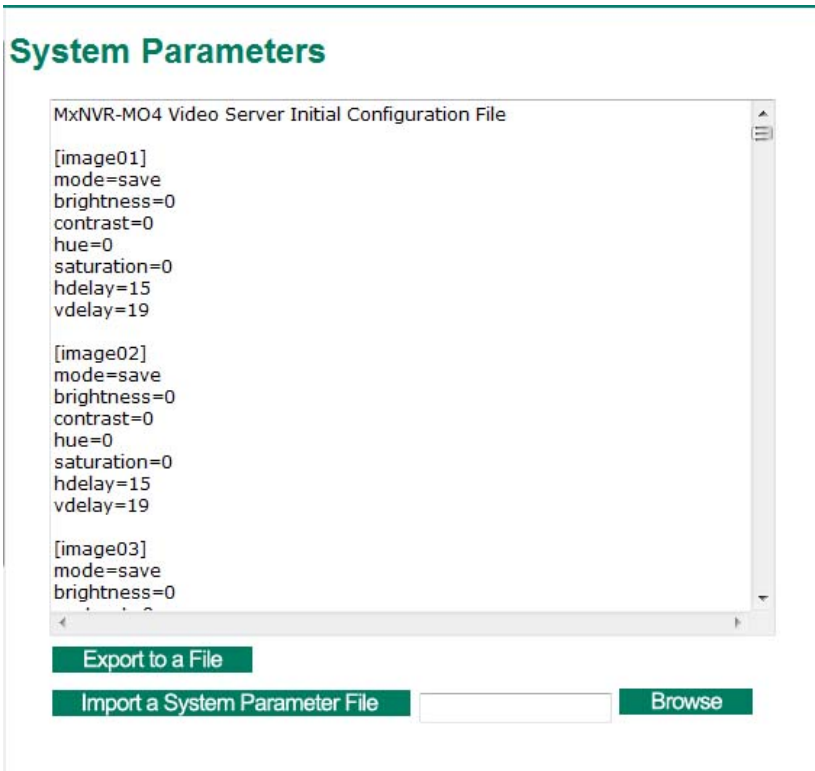

NOTE The system parameter import/export functions allow the administrator to backup and restore system configurations. The Administrator can export this sys_config.ini file (in a special binary format) for backup, and import the sys_config.ini file to restore the system configurations of MxNVR-MO4 video recorders. System configuration changes will take effect after the MxNVR-MO4 is rebooted.

Firmware Upgrade

Firmware Upgrade

Take the following steps to upgrade the firmware:

Step 1: Press the **Browse** button to select the firmware file.

NOTE For the MxNVR-MO4, the firmware file extension should be .rom.

Step 2: Click on the **Upgrade** button to upload the firmware to the MxNVR-MO4.

Step 3: The system will start to run the firmware upgrade process.

Step 4: Once **Firmware Update Success.....Reboot....** is displayed, please wait for few seconds for the MxNVR-MO4 to reboot. The reboot process is finished once the **STAT** LED is lit continuously in green.

NOTE Upgrading the firmware will not change the original settings.

Reset to Factory Default

From the “Reset to Factory Default” page, click on **OK** (as shown in the following figure) to reset the MxNVR-MO4 to its factory default settings.

Reset to Factory Default

Reset to Factory Default will restart the system and delete all the changes that have been made to the configuration. Are you sure you want to reset to factory default?

OK

NOTE All parameters will be reset to factory defaults when you use the Factory Default function. For this reason, if you want to keep a digital copy of the current configuration, remember to export the sys_config.ini file before using the Factory Default function.

Reboot

From the “Device Reboot” page, click **OK** (as shown in the following figure) to restart the MxNVR-MO4’s system.

Device Reboot

This device will reboot for restarting system. Are you sure you want to reboot?

OK

Network

General Network Settings

The **General Network Settings** page includes some basic but important network configurations that enable the MxNVR-MO4 to be connected to a TCP/IP network.

General Network Settings

Access Method	
<input checked="" type="radio"/>	DHCP
<input type="radio"/>	DHCP + Auto configure
<input type="radio"/>	Use fixed IP address
General Settings	
IP address	192.168.2.72
Subnet mask	255.255.255.0
Gateway	192.168.2.254
Primary DNS	192.168.50.33
Secondary DNS	192.168.1.97
HTTP	
HTTP port	80
RTSP Streaming	
RTSP port	554
Save	

Access Method

MxNVR-MO4 products support the DHCP protocol, which means that the MxNVR-MO4 can get its IP address from a DHCP server automatically when it is connected to a TCP/IP network. The Administrator should determine if it is more appropriate to use DHCP, or assign a fixed IP.

Setting	Description	Default
DHCP	Get the IP address automatically from the DHCP server.	DHCP
DHCP+ Auto configure	Get the IP address automatically from the DHCP server, and download the configurations from the TFTP server with Opt 66/67 mechanism.	
Use fixed IP address	Use the IP address assigned by the administrator.	

NOTE We strongly recommend that the administrator assign a fixed IP address to the MxNVR-MO4, since all of the functions and applications provided by the MxNVR-MO4 are active when the MxNVR-MO4 is connected to the network. Use DHCP to determine if the MxNVR-MO4's IP address may change when then network environment changes, or the IP address is occupied by other clients.

Auto Configuration

In a mass installation, it is time consuming to configure each of the many devices one by one. Therefore, DHCP Opt 66/67 provides a mechanism whereby configurations can be saved on a TFTP server. Once a new device is installed, the configurations can be downloaded to this new device automatically. By doing this, the installer can save a lot of time and efforts in mass device installation. Follow the steps below to use the auto-configuration function via Opt 66/67.

Step 1:

When MxNVR-MO4 enables the auto-configuration function, it will ask for the IP address from DHCP server, and the path of the TFTP server and configuration file.

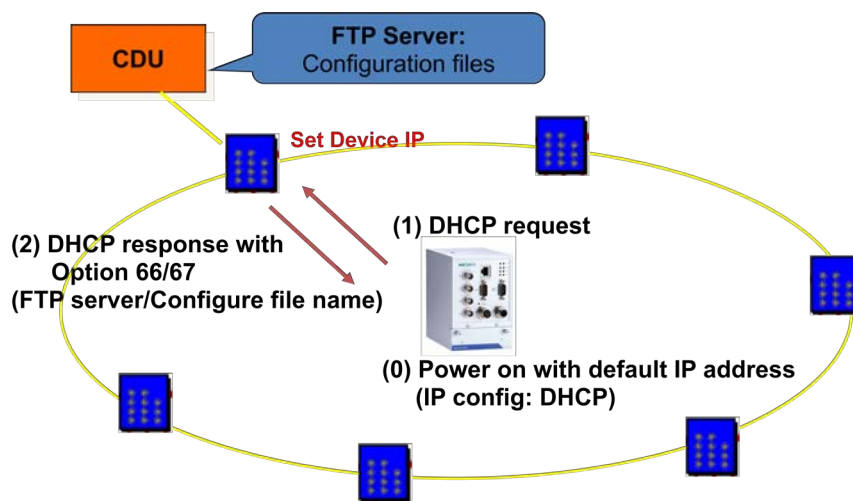

Step 2:

Once MxNVR-MO4 completes the IP settings, it will acquire the configuration file from the TFTP server, and check if this configuration file is right or not.

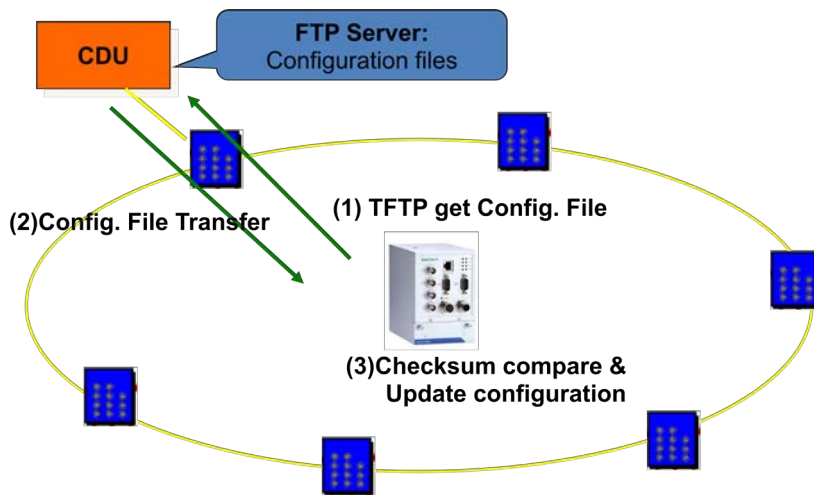

NOTE For the auto-configuration function to work, the system should

1. Have a DHCP Server that supports DHCP Opt 66/67 in the network switches and routers.
2. Have a TFTP server that supports the TFTP protocol

General Settings

Setting	Description	Default
IP address	Variable IP assigned automatically by the DHCP server, or fixed IP assigned by the Administrator.	192.168.127.100
Subnet mask	Variable subnet mask assigned automatically by the DHCP server, or a fixed subnet mask assigned by the Administrator.	255.255.255.0
Gateway	Assigned automatically by the DHCP server, or assigned by the Administrator.	Blank
Primary DNS	Enter the IP address of the DNS Server used by your network. After entering the DNS Server's IP address, you can input the MxNVR-MO4's url (e.g., www.MxNVR-MO4.company.com) in your browser's address field, instead of entering the IP address.	Obtained automatically from the DHCP server, or left blank in non-DHCP environments.
Secondary DNS	Enter the IP address of the DNS Server used by your network. The MxNVR-MO4 will try to locate the secondary DNS Server if the primary DNS Server fails to connect.	Obtained automatically from the DHCP server, or left blank in non-DHCP environments.

HTTP

Setting	Description	Default
HTTP Port (80, or 1024 to 65535)	HTTP port enables connecting the MxNVR-MO4 to the web.	80

RTSP Streaming

The MxNVR-MO4 364 supports standard RTSP (Real Time Streaming Protocol) streaming, which means that all devices and software that support RTSP can directly acquire and view the video images sent from the MxNVR-MO4 364 without any proprietary codec or SDK installations. This makes network system integration much more convenient. For different connection types, the **access name** is different. For UDP and TCP streams, the access name is **udpStream**. For HTTP streams, the access name is **moxa-cgi/udpstream_ch<channel number>**. For multicast streams, the access name is **multicastStream_ch<channel number>**. You can access the media through the following URL: **rtsp://<IP address>:<RTSP port>/<Access name>** for software that supports RTSP.

Setting	Description	Default
RTSP Port	An RTSP port is similar to an HTTP port, which can enable the connection of video/audio streams by RTSP.	554

The Apple QuickTime media player is used here as an example of a RTSP streaming application:

Step 1:

Open Apple QuickTime Player and select **File - Open URL in New Player**.



Step 2:

When the following pop-up window appears, type the URL in the input box. E.g., type:

rtsp://<MxNVR-MO4's IP address>[:<RTSP Port>]/udpstream_ch1_stream< 1 or 2>

rtsp://<MxNVR-MO4's IP address>[:<RTSP Port>]/multicaststream_ch1_stream<1 or 2>

RTSP Port: 554 is the default. Click **OK** to connect to the MxNVR-MO4 364.

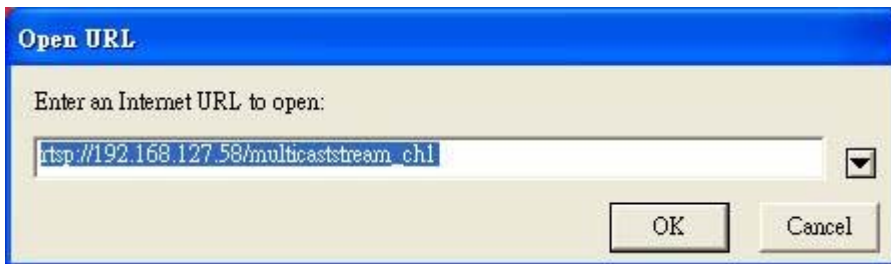

Step 3:

Wait a few seconds for QuickTime Player to establish the connection.



Step 4:

After the connection has been established, the MxNVR-MO4 364's video will appear in the QuickTime Player display window.



NOTE The video performance of the MxNVR-MO4 may vary when using other media players. For example, you will notice a greater delay when viewing the MxNVR-MO4's video from the QuickTime player compared to viewing it directly from the MxNVR-MO4's built-in web server. In addition, viewing the MxNVR-MO4's video from the QuickTime player through a router or Internet gateway could result in a broken connection.

NOTE For the time being, the MxNVR-MO4's RTSP video/audio stream can be identified and viewed by Apple QuickTime Ver. 6.5 and above, and the VLC media player. System integrators can use these 2 media players to view the MxNVR-MO4's video directly, without needing to use the MxNVR-MO4's SDK to create customized software.

NOTE When using RTSP, the video stream format should be H.264. MJPEG does not support RTSP.

SMTP Server and Email Account Settings

The MxNVR-MO4 not only plays the role of a server, but can also connect to outside servers to send alarm messages and snapshots. If the administrator has set up some applications in either system information or alarm, the MxNVR-MO4 will send out messages or snapshots once these conditions occur.

SMTP Server and Email Account Settings

1st SMTP Server and Sender Email

1st SMTP (mail) server

1st SMTP account name

1st SMTP password

1st Sender's email address

2nd SMTP Server and Sender Email

2nd SMTP (mail) server

2nd SMTP account name

2nd SMTP password

2nd Sender's email address

Note: There are 2 SMTP servers and sender Email accounts for sending system information and alarms. enable the email transmitting system.

Recipient's Email

1st Recipient's Email Address:

2nd Recipient's Email Address:

Note: There are 2 recipient email accounts for receiving system information and alarms.

Save

1st SMTP Server and Sender Email

Setting	Description	Default
1st SMTP (mail) server	SMTP Server's IP address or URL address.	None
1st SMTP account name	For security reasons, most SMTP servers require the account name and password to be authenticated.	None
1st SMTP password		None
1st Sender's email address	For security reasons, SMTP servers must see the exact sender email address.	None

NOTE Note that if the **Sender's email address** is not set, a warning message will pop up and the e-mail system will not be allowed to operate.

NOTE The **2nd SMTP Server** and Sender Email are backups that are used if the 1st SMTP Server and Sender Email fail when connecting or sending email.

Two recipient email accounts are available for receiving emails sent by the MxNVR-MO4. For redundancy, both addresses receive the sent messages and alarm snapshots simultaneously.

Setting	Description	Default
1st Recipient's Email Address	Email address of the 1st recipient.	None
2nd Recipient's Email Address	Email address of the 2nd recipient.	None

FTP Server Settings

FTP is the other method available for the MxNVR-MO4 to send alarm messages and snapshots.

FTP Server Settings

1st FTP server

1st FTP server

1st FTP server port

1st FTP user name

1st FTP password

1st FTP remote folder

1st FTP passive mode

2nd FTP server

2nd FTP server

2nd FTP server port

2nd FTP user name

2nd FTP password

2nd FTP remote folder

2nd FTP passive mode

Note: There are 2 FTP servers for sending alarms. At least one of them should be set up correctly to enable the FTP s;

Save

1st FTP Server

Setting	Description	Default
1st FTP server	FTP server's IP address or URL address.	None
1st FTP server port	FTP server's authentication.	None
1st FTP user name		None
1st FTP remote folder	FTP file storage folder on the remote FTP server.	None
1st FTP passive mode	Passive transfer solution for FTP transmission through a firewall.	Disabled

NOTE The 2nd FTP Server is a backup in case the 1st FTP Server fails to connect or has trouble sending files.

NOTE Whenever the system reboots, a system log will be sent by email or FTP to show the login status of the MxNVR-MO4. The system log will be sent to the Sender email address if the SMTP server settings are correct. To send the system log via FTP, the SMTP server should be erased since the E-mail system is used by default to transmit the system log.

NOTE For either e-mail or FTP, the information of the 1st server should be entered first. If the 1st server is not set, the related FTP or email will be cancelled. Note that it may take time to connect to the 2nd server after the first server fails, and this may affect some applications when adverse conditions occur too often.

Dynamic DNS

DDNS (Dynamic Domain Name System) is a combination of DHCP, DNS, and client registration. DDNS allows administrators to alias the MxNVR-MO4's dynamic IP address to a static hostname in any of the domains provided by the DDNS service providers listed on the MxNVR-MO4's Network/DDNS configuration page. DDNS makes it easier to access the MxNVR-MO4 from various locations on the Internet.

Setting	Description	Default
Enable DDNS	Enable or disable DDNS function	Disable
Provider	Select the DDNS service providers, including DynDNS.org (Dynamic), DynDNS.org (Custom), TZO.com, and dhs.org.	None
Host Name	The Host Name you use to link to the MxNVR-MO4.	None
Username/ E-mail	The Username/E-mail and Password/Key are used to enable the service from the DDNS service provider (based on the rules of DDNS websites).	None
Password/ Key		None

NOTE Dynamic DNS is a very useful tool for accessing a MxNVR-MO4 over the Internet, especially for xDSL connections with a non-fixed IP address (DHCP). The administrator and users can simplify connecting to a MxNVR-MO4 with a non-fixed IP address, by using the unique host name in the URL to establish a connection with the MxNVR-MO4.

NOTE Different DDNS service providers have different application rules. Some applications are free of charge, but most require an application fee.

Universal PnP

UPnP (Universal Plug & Play) is a networking architecture that provides compatibility among the networking equipment, software, and peripherals of the 400+ vendors that are part of the Universal Plug and Play Forum. This means that they are listed in the network devices table for the operating system (such as Windows XP) supported by this function. Users can link to the MxNVR-MO4 directly by clicking on the MxNVR-MO4 listed in the network devices table.

Universal PnP

UPnP (Universal Plug & Play) is a function that provides compatibility among networking equipment, software and peripherals. By enabling this function, you can find this VPort directly from the operating system's network device list.

Enable UPnP

Note: Please make sure your OS or software supports UPnP first if you want to enable VPort's UPnP function.

Save

Setting	Description	Default
Enable UPnP	Enable or disable the UPnP function.	Enable

Multicast

The MxNVR-MO4 supports the advanced Multicast network protocol IGMP, which can greatly improve the efficiency of network traffic. In this section, we explain multicasts, multicast filtering, and how multicast can be implemented on your MxNVR-MO4.

What is Multicast?

A multicast is a packet that is intended for “one-to-many” and “many-to-many” communication. Users explicitly request to participate in the communication by joining an end-station to a specific multicast group. If the network is set up correctly, a multicast can only be sent to an end-station or a subset of end-stations on a LAN or VLAN that belongs to the relevant multicast group. Multicast group members can be distributed across multiple subnetworks. Therefore, multicast transmissions can occur within a campus LAN or over a WAN. In addition, networks that support IP multicast send only one copy of the desired information across the network. The packets are only replicated if they reach a network node that links to two or more members of the multicast network. Transmitting packets in this way makes more efficient use of network bandwidth. A multicast packet is identified by the presence of a multicast group address in the destination address field of the packet’s IP header.

Benefits of Multicast

The benefits of using IP multicast are that it:

- Enables the simultaneous delivery of information to many receivers in the most efficient, logical way.
- Reduces the load on the source (for example, a server) because it does not need to produce multiple copies of the same data.
- Makes efficient use of network bandwidth and scales well as the number of participants or collaborators expands.
- Works with other IP protocols and services, such as Quality of Service (QoS).

There are situations where a multicast approach is more logical and efficient than a unicast approach. A typical use of multicasts is in video-conferencing, in which high volumes of traffic need to be sent to several end-stations simultaneously, but for which broadcasting that traffic to all end-stations would seriously reduce network performance. Several industrial automation protocols, such as Allen-Bradley, EtherNet/IP, Siemens Profibus, and Foundation Fieldbus HSE (High Speed Ethernet), use the multicast approach. These industrial Ethernet protocols use publisher/subscriber communications models by multicasting packets that could flood a network with heavy traffic. IGMP provides the ability to prune multicast traffic so that it travels only to those end destinations that require the traffic, thus reducing the amount of traffic on the Ethernet LAN.

The network WITHOUT Multicast

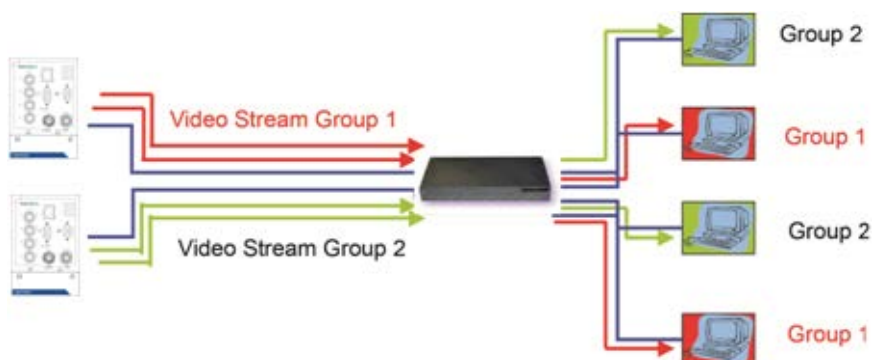

The network WITH Multicast

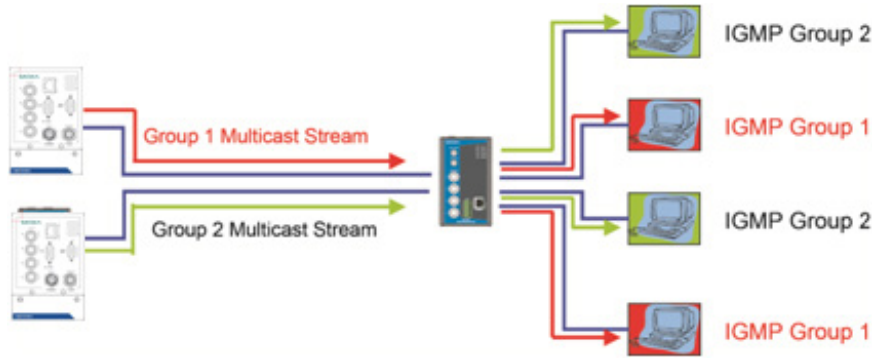

NOTE The MxNVR-MO4 is the source that delivers the multicast video stream. To benefit from the Multicast protocol, the gateway or network switch should support the multicast filtering function (such as IGMP Snooping) so that the multicast stream is delivered correctly and precisely. To learn more about IGMP Snooping, refer to the Moxa EtherDevice™ series Industrial Ethernet Switch user’s manual.

Configuring Multicast Settings

Multicast Settings

<p>Channel 1</p> <p>Multicast group address: <input type="text" value="239.127.0.100"/></p> <p>Multicast video port: <input type="text" value="5556"/></p> <p>Multicast audio port: <input type="text" value="5558"/></p> <p>Multicast TTL: <input type="text" value="128"/></p> <p>Continuous Multicast Push: <input type="checkbox"/> Enable</p>	<p>Channel 2</p> <p>Multicast group address: <input type="text" value="239.127.0.100"/></p> <p>Multicast video port: <input type="text" value="5560"/></p> <p>Multicast audio port: <input type="text" value="5562"/></p> <p>Multicast TTL: <input type="text" value="128"/></p> <p>Continuous Multicast Push: <input type="checkbox"/> Enable</p>
<p>Channel 3</p> <p>Multicast group address: <input type="text" value="239.127.0.100"/></p> <p>Multicast video port: <input type="text" value="5564"/></p> <p>Multicast audio port: <input type="text" value="5566"/></p> <p>Multicast TTL: <input type="text" value="128"/></p> <p>Continuous Multicast Push: <input type="checkbox"/> Enable</p>	<p>Channel 4</p> <p>Multicast group address: <input type="text" value="239.127.0.100"/></p> <p>Multicast video port: <input type="text" value="5568"/></p> <p>Multicast audio port: <input type="text" value="5570"/></p> <p>Multicast TTL: <input type="text" value="128"/></p> <p>Continuous Multicast Push: <input type="checkbox"/> Enable</p>

Setting	Description	Default
Multicast group address	Multicast Group address for sending video stream.	239.127.0.100
Multicast video port	Video port number.	Channel 1: 5556 Channel 2: 5560 Channel 3: 5564 Channel 4: 5568
Multicast audio port	Audio port number.	Channel 1: 5558 Channel 2: 5562 Channel 3: 5566 Channel 4: 5570
Multicast TTL	Multicast-TTL (Time-to-live) threshold. There is a certain TTL threshold defined for each network interface or tunnel. A multicast packet’s TTL must be larger than the defined TTL for that packet to be forwarded across that link.	128
Continuous Multicast Push	Enable PUSH control of the multicast video stream	Disable

NOTE Whenever you enable the MxNVR-MO4’s IGMP Multicast stream, note the video/audio port number.

Accessible IP List

The MxNVR-MO4 uses an IP address-based filtering method to control access to the MxNVR-MO4.

Accessible IP List

Enable accessible IP list ("Disable" will allow all IPs to connect)

Index	IP	NetMask
1		
2		
3		
4		
5		
6		
7		
8		
9		
10		

Save

Accessible IP Settings allow you to add or remove "Legal" remote host IP addresses to prevent unauthorized access. Access to the MxNVR-MO4 is controlled by IP address. That is, if a host's IP address is in the accessible IP table, then the host will be allowed access to the MxNVR-MO4. Administrators can allow one of the following cases by setting this parameter:

- Only one host with a specific IP address can access the MxNVR-MO4. Enter "IP address/255.255.255.255" (e.g., 192.168.1.1/255.255.255.255)
- Hosts on a specific subnet can access the MxNVR-MO4. Enter "IP address/255.255.255.0" (e.g., "192.168.1.0/255.255.255.0")
- Any host can access the MxNVR-MO4. Disable this function.

Refer to the following table for more configuration examples.

Allowable Hosts	Input Formats
Any host	Disable
192.168.1.120	192.168.1.120/255.255.255.255
192.168.1.1 to 192.168.1.254	192.168.1.0/255.255.255.0
192.168.0.1 to 192.168.255.254	192.168.0.0/255.255.0.0
192.168.1.1 to 192.168.1.126	192.168.1.0/255.255.255.128
192.168.1.129 to 192.168.1.254	192.168.1.128/255.255.255.128

SNMP

The MxNVR-MO4 supports three SNMP protocols. The available protocols are SNMP V1, SNMP V2c, and SNMP V3. SNMP V1 and SNMP V2c use a community string match for authentication, which means that SNMP servers access all objects with read-only or read/write permissions using the community string public/private (default value). SNMP V3, which requires you to select an authentication level of MD5 or SHA, is the most secure protocol. You can also enable data encryption to enhance data security. SNMP security modes and security levels supported by the MxNVR-MO4 are shown in the following table. Select one of these options to communicate between the SNMP agent and manager.

Protocol Version	Security Mode	Authentication Type	Data Encryption	Method
SNMP V1, V2c	V1, V2c Read Community	Community string	No	Use a community string match for authentication
	V1, V2c Write/Read Community	Community string	No	Use a community string match for authentication
SNMP V3	No-Auth	No	No	Use account with admin or user to access objects
	MD5 or SHA	MD5 or SHA	No	Provides authentication based on HMAC-MD5, or HMAC-SHA algorithms. 8-character passwords are the minimum requirement for authentication.
	MD5 or SHA	MD5 or SHA	Data encryption key	Provides authentication based on HMAC-MD5 or HMAC-SHA algorithms, and data encryption key. 8-character passwords and a data encryption key are the minimum requirements for authentication and encryption.

Configuring SNMP Settings

The following figures indicate which SNMP parameters can be configured. A more detailed explanation of each parameter is given below the figure.

SNMP

SNMP Read/Write Settings

SNMP Versions V1, V2c, V3 ▼

V1,V2c Read Community

V1,V2c Write/Read Community

V3 Admin Read/Write Auth. Mode No-Auth ▼

V3 Admin Read/Write Private Mode Key:

Trap Settings

1st Trap Server IP/Name

1st Trap Community

2nd Trap Server IP/Name

2nd Trap Community

Private MIB information

Object ID enterprise.8691.8.5.2

Save

SNMP Read/ Write Settings

SNMP Versions

Setting	Description	Default
V1, V2c, V3	Select SNMP protocol versions V1, V2c, V3 to manage the switch	V1, V2c
V1, V2c	Select SNMP protocol versions V1, V2c to manage the switch	
V3 only	Select SNMP protocol versions V3 only to manage the switch	

V1, V2c Read Community

Setting	Description	Default
V1, V2c Read Community	Use a community string match for authentication, which means that the SNMP agent accesses all objects with read-only permissions using the community string public.	public (max. 30 characters)

V1, V2c Read/Write Community

Setting	Description	Default
V1, V2c Read/Write Community	Use a community string match for authentication, which means that the SNMP agent accesses all objects with read-only permissions using the community string public.	public (max. 30 characters)

For SNMP V3, there are two levels of privilege for different accounts to access the MxNVR-MO4. Admin privilege allows access and authorization to read and write MIB files. User privilege only allows reading the MIB file, but does not authorize writing to the file.

Root Auth. Type (For SNMP V1, V2c, V3 and V3 only)

Setting	Description	Default
No-Auth	Use admin. account to access objects. No authentication.	No
MD5-Auth	Provide authentication based on the HMAC-MD5 algorithms. 8-character passwords are the minimum requirement for authentication.	No
SHA- Auth	Provide authentication based on the MAC-SHA algorithms. 8-character passwords are the minimum requirement for authentication.	No

Root Data Encryption Key (For SNMP V1, V2c, V3 and V3 only)

Setting	Description	Default
Enable	8-character data encryption key is the minimum requirement for data encryption. Maximum 30-character encryption key.	No
Disable	No data encryption.	No

User Auth. Type (For SNMP V1, V2c, V3 and V3 only)

Setting	Description	Default
No-Auth	Use account of admin or user to access objects. No authentication.	No
MD5-Auth	Provide authentication based on the HMAC-MD5 algorithms. 8-character passwords are the minimum requirement for authentication.	No
SHA- Auth	Provide authentication based on the HMAC-SHA algorithms. 8-character passwords are the minimum requirement for authentication.	No

User Data Encryption Key (For SNMP V1, V2c, V3 and V3 only)

Setting	Description	Default
Enable	8-character data encryption key is the minimum requirement for data encryption. Maximum 30-character encryption key.	No
Disable	No data encryption.	No

Trap Settings

Setting	Description	Default
Trap Server IP/Name	Enter the IP address or name of the Trap Server used by your network.	No
Trap Community	Use a community string match for authentication; Maximum of 30 characters.	No

Private MIB information

The private SNMP Object ID of the MxNVR-MO4 is the enterprise value: 8691.8.5.2. This number cannot be changed.

NOTE The MIB file is MOXA-MXNVR-MO4364-MIB.mib (or.my). You can find it on the software CD or the download center of the Moxa website.

QoS (ToS)

Quality of Service (QoS) provides traffic prioritization capabilities to ensure that important data is delivered consistently and predictably. The MxNVR-MO4 can inspect layer 3 ToS (Type of Service) information to provide a consistent classification of the entire network. The MxNVR-MO4's ToS capability improves your industrial network's performance and determinism for mission critical applications.

QoS(ToS)

Configure the QoS (ToS) to add the ToS (Type of Service) tag onto the video streaming data for transmitting this video stream with higher priority compared to other data.

Enable ToS

DSCP Value

Setting	Description	Factory Default
Enable ToS	Enable the ToS for transmitting the video stream with the given priority	Disable
DSCP Value	Set the mapping table with different ToS values	0, 0

NOTE To configure the ToS values, map to the network environment settings for QoS priority service.

HTTP Event Server

The MxNVR-MO4 can send the customized alarm actions and messages to the HTTP Event Servers, which allows users to design a customized alarm system.

HTTP Event Servers

VPort can send the customized alarm actions and messages to the HTTP Event Ser capability for the users designing the customized alarm system.

Hostname

Server 1

User name:

Password:

Server 2

User name:

Password:

Server 3

User name:

Password:

Server 4

User name:

Password:

Save

Setting	Description	Factory Default
Host Name	User-defined name for identification	Blank
Server 1, 2, 3, 4	The server's URL address with complete CGI commands Ex. http:// http event server:Port/CGI_Name	Blank
User name	The account name for accessing the HTTP server	Blank
Password	The password for accessing the HTTP server	Blank

Once the Http Alarm is triggered, the MxNVR-MO4 will send the following HTTP commands to the HTTP event servers.

```
GET CGI_Name?address=<Hostname or IP Address>&[Custom CGI] HTTP/1.0\r\n
User-Agent: MxNVR-MO4 Recorder V1.1\r\n
[Authorization: Basic <Buse64(username:password)>\r\n]
Host: <HTTP Server IP Address>\r\n
Connection: Keep-Alive\r\n
\r\n
```

Modbus/TCP

Modbus is a serial communications protocol which is often used to connect a supervisory computer with a remote terminal unit (RTU) in supervisory control and data acquisition (SCADA) systems. To transmit Modbus over a TCP/IP network, a standard Modbus/TCP protocol is provided. With the support of the Modbus/TCP protocol, the SCADA/HMI system can directly communicate with the MxNVR-MO4 to acquire its operational status.

ModBus/TCP

Modbus is a serial communications protocol for the industrial devices' communications with the SCADA/HMI system. With the Modbus/TCP protocol, the SCADA/ HMI system can directly communicate with VPort for acquiring the working status.

Enable ModBus/TCP

Save

Setting	Description	Factory Default
Enable Modbus/TCP	Enable the Modbus/TCP protocol	Enable

NOTE For the Modbus address table, please refer to the appendix: Modbus Address Table

IEEE 802.1X

The MxNVR-MO4 supports advanced IEEE 802.1X network authentication function. There are three types of 802.1X supported: EAP-MD5, EAP-PEAP/MSCHAPv2 and EAP-TLS. The Administrator should choose the appropriate type base on the network system situation.

EAP-MD5

IEEE 802.1X

Enable 802.1X

EAP Method: EAP-MD5 ▼

Username:

Password:

Save

EAP-PEAP/MSCHAPv2

IEEE 802.1X

Enable 802.1X

EAP Method: EAP-PEAP/MSCHAPv2 ▼

Identify:

Password:

CA Certificate: Browse Upgrade

CA Certificate Status: no file

Save

EAP-TLS

IEEE 802.1X

Enable 802.1X

EAP Method:

Identify:

CA Certificate:

CA Certificate Status: no file

Client Certificate:

Client Certificate Status: no file

Client Private Key:

Client Private Key Status: no file

Client Private Key Password:

NOTE Please consult an expert or your network administrator for the configurations of 802.1X if you have trouble in it.

DynaStream™

DynaStream™ is a unique and innovative function that allows for adaptive frame rates in response to events on the network, such as event triggers and system commands. When network traffic becomes congested, DynaStream™ allows MxNVR-MO4 products to respond to CGI, SNMP, and Modbus commands from SCADA (as well as the MxNVR-MO4's VMD, DI, CGI events, and video loss triggers) and automatically decrease the frame rates to reduce bandwidth consumption. This reserves bandwidth for the SCADA system to maintain Quality of Service (QoS) and guarantees that the SCADA performance will not be impacted by video traffic. For example, the frame rate can be set low during regular streaming to reduce bandwidth usage and automatically switch to a high frame rate during triggered events to ensure quick transmission of critical video data or video streams, or to provide detailed visual images for problem analysis.

NOTE For enabling the DynaStream function from CGI commands and Modbus TCP, please refer to the CGI Commands User's Manual of MxNVR-MO4 SDK PLUS and Modbus Address Table

Basic

The administrator can adjust the number of frames per second for each channel. There are two types of frame rate status: Live and Alarm. Live status refers to the normal frames rates for live video displays. Alarm status refers to what the frame rate will be adjusted to when the DynaStream function is activated.

Currently, the video stream for DynaStream is only set up for H.264 video streams, and the resolution and quality are the same as for the settings in the Video Performance configuration.

DynaStream Basic Setting

This innovative Dynastream function is to change the video streams' frame rate automatically once an event/ alarm is happened (VPort's alarms or external events). This change can be from low to high frame rate to increase the smooth of the video streams, or from high to low frame rate to lower down the bandwidth consumption. The Live is to setup the current frame rate, and the Alarm is to setup the frame rate after being changed by an alarm/ event.

Channel	Stream	Status	Max FPS	Resolution	Quality	Preview
Channel 1	H.264	Live	<input type="text" value="30"/>	720x480	Fixed quality:	<input type="button" value="Test"/>
		Alarm	<input type="text" value="30"/>			
Channel 2	H.264	Live	<input type="text" value="30"/>	720x480	Fixed quality:	<input type="button" value="Test"/>
		Alarm	<input type="text" value="30"/>			
Channel 3	H.264	Live	<input type="text" value="30"/>	720x480	Fixed quality:	<input type="button" value="Test"/>
		Alarm	<input type="text" value="30"/>			
Channel 4	H.264	Live	<input type="text" value="30"/>	720x480	Fixed quality:	<input type="button" value="Test"/>
		Alarm	<input type="text" value="30"/>			



Setting	Description	Factory Default
Max. FPS	For setting the maximum frame rate per second.	30 FPS

After setting the Alarm frame rate, you may preview the video performance by clicking the Test button to ensure it meets your requirements

Conditions

The administrator can set up DynaStream's trigger conditions for facilitating automatic frame rate adjustment, e.g., from Live to Alarm status.

Currently, there are four types of trigger conditions: Digital Input, CGI Event, Motion Detection, and Video Loss.

DynaStream Trigger Conditions

The Dynastream can be triggered by the alarms VPort has, including Digital Input, CGI Event, Video Motion Detection and Video Loss. This page can setup the trigger conditions and the duration this Dynastream works.

Digital Input

Input No.	Enable	Duration	Trigger Channel
DI1	<input type="checkbox"/>	5 sec(s)	<input type="checkbox"/> CH1 <input type="checkbox"/> CH2 <input type="checkbox"/> CH3 <input type="checkbox"/> CH4
DI2	<input type="checkbox"/>	5 sec(s)	<input type="checkbox"/> CH1 <input type="checkbox"/> CH2 <input type="checkbox"/> CH3 <input type="checkbox"/> CH4
DI3	<input type="checkbox"/>	5 sec(s)	<input type="checkbox"/> CH1 <input type="checkbox"/> CH2 <input type="checkbox"/> CH3 <input type="checkbox"/> CH4
DI4	<input type="checkbox"/>	5 sec(s)	<input type="checkbox"/> CH1 <input type="checkbox"/> CH2 <input type="checkbox"/> CH3 <input type="checkbox"/> CH4

CGI Event

Event No.	Enable	Duration	Trigger Channel
Event 1	<input type="checkbox"/>	5 sec(s)	<input type="checkbox"/> CH1 <input type="checkbox"/> CH2 <input type="checkbox"/> CH3 <input type="checkbox"/> CH4
Event 2	<input type="checkbox"/>	5 sec(s)	<input type="checkbox"/> CH1 <input type="checkbox"/> CH2 <input type="checkbox"/> CH3 <input type="checkbox"/> CH4
Event 3	<input type="checkbox"/>	5 sec(s)	<input type="checkbox"/> CH1 <input type="checkbox"/> CH2 <input type="checkbox"/> CH3 <input type="checkbox"/> CH4
Event 4	<input type="checkbox"/>	5 sec(s)	<input type="checkbox"/> CH1 <input type="checkbox"/> CH2 <input type="checkbox"/> CH3 <input type="checkbox"/> CH4
Event 5	<input type="checkbox"/>	5 sec(s)	<input type="checkbox"/> CH1 <input type="checkbox"/> CH2 <input type="checkbox"/> CH3 <input type="checkbox"/> CH4

Motion Detection

Channel 1			Channel 2			Channel 3			Channel 4		
VMD	Enable	Duration	VMD	Enable	Duration	VMD	Enable	Duration	VMD	Enable	Duration
1	<input type="checkbox"/>	5 sec(s)	1	<input type="checkbox"/>	5 sec(s)	1	<input type="checkbox"/>	5 sec(s)	1	<input type="checkbox"/>	5 sec(s)
2	<input type="checkbox"/>	5 sec(s)	2	<input type="checkbox"/>	5 sec(s)	2	<input type="checkbox"/>	5 sec(s)	2	<input type="checkbox"/>	5 sec(s)
3	<input type="checkbox"/>	5 sec(s)	3	<input type="checkbox"/>	5 sec(s)	3	<input type="checkbox"/>	5 sec(s)	3	<input type="checkbox"/>	5 sec(s)

Video Loss

Channel	Enable	Duration
CH 1	<input type="checkbox"/>	5 sec(s)
CH 2	<input type="checkbox"/>	5 sec(s)
CH 3	<input type="checkbox"/>	5 sec(s)
CH 4	<input type="checkbox"/>	5 sec(s)

Setting	Description	Factory Default
Enable	To enable or disable the DynaStream function.	Disabled
Duration	This refers to the time period that DynaStream is in operation. For example, if the duration is set to 5 seconds, then the frame rate will change from the Live to the Alarm status for the duration of 5 seconds. After 5 seconds, the frame rate will return to the Live status setting.	5 seconds
Trigger Channel	To enable or disable the video channels.	Disabled

Video

Image Settings

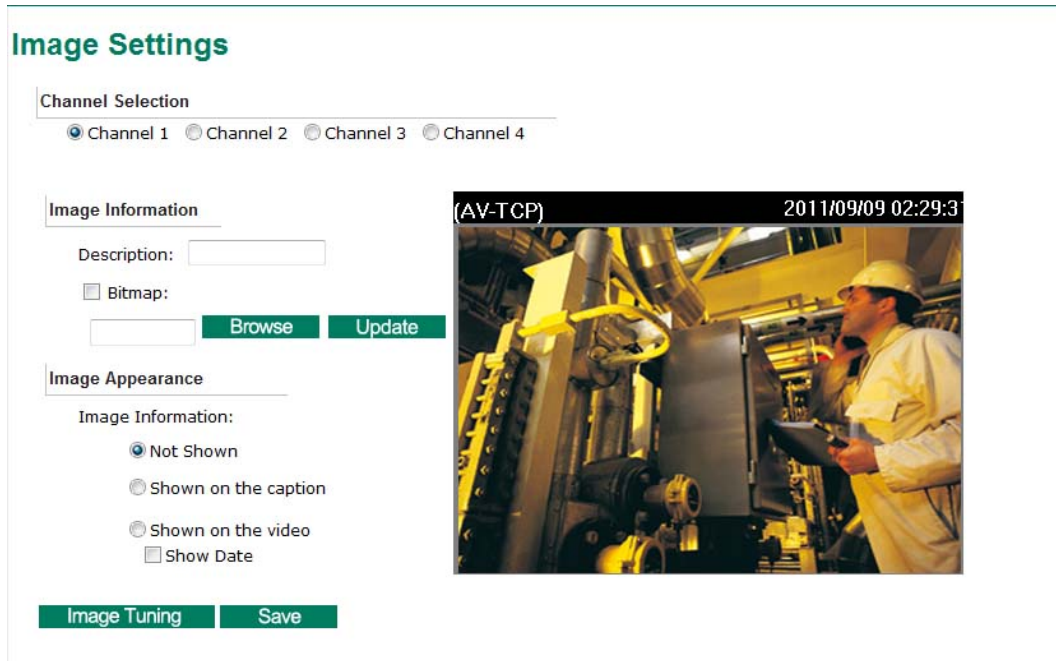

Channel Selection

	Description	Default
Channel 1, 2, 3, or 4	For configuring the channels' image settings.	Channel 1

Image Information Setting

	Description	Default
Description (max. of 14 characters)	The customized description shown on the caption or the image to identify this video camera.	None
Bitmap	This function is reserved for custom descriptions in a non-English language	None

NOTE The Bitmap is used to provide a customized description in a non-English language. Please contact Moxa Technical support to use this service.

Image Appearance Setting

	Description	Default
Image Information	To determine what style of image information is being shown. Includes Not Shown, Shown on the Caption or Shown on the Video. The checkbox of Show Date is to attach the date in the description.	Not Shown

Image Tuning

An Image Tuning button is available for the administrator to fine tune image attributes. After clicking this button, a configuration window will pop up. You may configure **Brightness**, **Contrast**, **Saturation**, and **Hue**. The **Vertical** and **Horizontal** configurations are for adjusting image positions. Administrators can click **Preview** to determine if the tuning adjustments meet their requirements. Click **Restore** to change back to the original tuning configurations.



Brightness Saturation
 Contrast Hue
 Image Adjust
 Vertical Horizontal

Camera Modulation

The MxNVR-MO4 supports both NTSC and PAL camera modulations. The Administrator can use automatic sensing by selecting **NTSC** or **PAL**.

Camera Modulation

- NTSC
- PAL

Note: If you change the modulation, the server will restart and you will need to reconnect to the server by reloading the web page.

NOTE Changing the modulation requires resetting the server to detect the camera. Please ensure that your configurations are saved before resetting the server.

Video Performance

The MxNVR-MO4 364 can send dual video streams simultaneously: one H.264 and one MJPEG. Each video stream can be used for a different specific application.

Encode Standard, Resolution (Size), Frame Rate and Quality

Channel	Stream Select	Resolution	Max FPS	Quality	Enable Snapshot
Channel 1	<input checked="" type="checkbox"/> H.264	720x480	30	Fixed quality Good	<input checked="" type="checkbox"/>
	<input checked="" type="checkbox"/> MJPEG	720x480	1	Fixed quality Good	
Channel 2	<input checked="" type="checkbox"/> H.264	720x480	30	Fixed quality Good	<input checked="" type="checkbox"/>
	<input checked="" type="checkbox"/> MJPEG	720x480	1	Fixed quality Good	
Channel 3	<input checked="" type="checkbox"/> H.264	720x480	30	Fixed quality Good	<input checked="" type="checkbox"/>
	<input checked="" type="checkbox"/> MJPEG	720x480	1	Fixed quality Good	
Channel 4	<input checked="" type="checkbox"/> H.264	720x480	30	Fixed quality Good	<input checked="" type="checkbox"/>
	<input checked="" type="checkbox"/> MJPEG	720x480	1	Fixed quality Good	

Note: The quality setting of Fixed Bit Rate is only for H.264 video streams.

Stream Select

Setting	Description	Default
H.264 or MJPEG	Select either the H.264 format, MJPEG format, or both..	Enabled

Resolution

The MxNVR-MO4 364 supports 5 different resolutions: Full D1, 4CIF, VGA, CIF, and QCIF.

Setting	Description	Default
Select the image size	5 image resolutions (size) are provided. The administrator can choose each option with NTSC or PAL modulation.	720 x 480 in NTSC or 720 x 576 in PAL

Resolution	NTSC	PAL
Full D1	720 x 480	720 x 576
4CIF	704 x 480	704 x 576
VGA	640 x 480	640 x 480
CIF	352 x 240	352 x 288
QCIF	176 x 112	176 x 144

Max. FPS (Frame per second)

Setting	Description	Default
Maximum frame rate	The maximum frame rate is different to accommodate different modulations of video input. Administrators can also set up the maximum frame rate to optimize bandwidth use. NTSC: 1, 3, 5, 10, 15, 20, 25, 30 PAL: 1, 3, 5, 8, 12, 16, 20, 25	H.264: 30 for NTSC and 25 for PAL MJPEG: 1 for both NTSC and PAL

NOTE The total frame rate of each channel is 30 in NTSC, and 25 in PAL, which means if the H.264 video stream is set for 20 frames/second in NTSC, then the maximum frame rate of the MJPEG video stream is 10 frames/second in NTSC.

NOTE Frame rate (frames per second) is determined by the resolution, image data size (bit rate), and transmission traffic status. The Administrator and users can check the frame rate status in the FPS Status on the MxNVR-MO4's web homepage.

Video Quality Control

Video Quality Control is used to optimize the bandwidth of the video stream. There are 2 modes for video quality control.

Setting	Description	Default
Fixed bit rate (Only for H.264)	The administrator can fix the bandwidth to tune the video quality and FPS (frames per second) to the optimum combination. Different resolutions have different bandwidth parameters. The MxNVR-MO4 will tune the video performance according to the bandwidth. A higher bandwidth means better quality.	600Kbps in Full D1 resolution
Fixed Quality	The administrator can set the image quality to one of 5 standards: Medium, Standard, Good, Detailed, or Excellent. The MxNVR-MO4 will tune the bandwidth and FPS automatically to the optimum combination.	Good

	720X480(N) 720X576(P)	704X480(N) 704X576(P)	640X480(N) 640X480(P)	352X240(N) 352X288(P)	176X112(N) 176X144(P)
B1	600 Kbps	570 Kbps	534 Kbps	144 Kbps	36 Kbps
B2	1200 Kbps	1140 Kbps	1068 Kbps	288 Kbps	72 Kbps
B3	1800 Kbps	1710 Kbps	1602 Kbps	432 Kbps	108 Kbps
B4	2400 Kbps	2280 Kbps	2136 Kbps	576 Kbps	144 Kbps
B5	3000 Kbps	2850 Kbps	2670 Kbps	720 Kbps	180 Kbps
B6	3600 Kbps	3420 Kbps	3204 Kbps	864 Kbps	216 Kbps
B7	4200 Kbps	3990 Kbps	3738 Kbps	1008 Kbps	252 Kbps

NOTE The image quality, FPS, and bandwidth are influenced significantly by network throughput, system network bandwidth management, applications the MxNVR-MO4 runs (such as VMD), how complicated the image is, and the performance of your PC or notebook when displaying images. The administrator should take into consideration all of these variables when designing the video over IP system, and when specifying the requirements for the video system.

Audio

Audio Source

The MxNVR-MO4 supports 2 audio inputs for real-time and synchronous video/audio transmission. Administrators need to select the correct audio input type to avoid audio input distortion.

Setting	Description	Default
Audio Source	MIC-in (microphone) and Line-in (voice amplifier) options are available.	Line in



Alarm

System Alarm

In addition to the LED indicators, three kinds of system alarms are provided by the MxNVR-MO4 364 for notifying the system operations administrator.

System Alarm

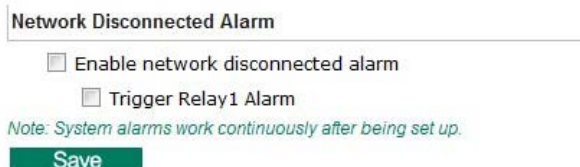

Alarm Type	Triggered Condition	Triggered Action
Network Disconnected	Network disconnected	Relay

Network Disconnected Alarm

Setting	Description	Default
Enable network disconnected alarm	Enable or disable network disconnected alarm.	Disable
Trigger Relay alarm	Enable or disable the triggering of Relay 1 or Relay 2 alarms.	Disable

NOTE Since several alarms can be set up to trigger the MxNVR-MO4's relays, the administrator should configure these alarms carefully in case a relay message is read incorrectly.

Event Alarm

Four kinds of event alarm are provided by the MxNVR-MO4 for building an intelligent video surveillance system.

Alarm Type	Triggered Condition	Triggered Action
Video Motion Detection (VMD)	VMD 1 VMD 2 VMD 3	1. Relay 2. Email 3. FTP 4. HTTP Event Server 5. Record video on HDD
Digital Inputs	DI 1 DI 2	1. Relay 2. Email 3. FTP 4. HTTP Event Server 5. Record video on HDD
Video Loss	Video signal is lost	1. Relay 2. Email 3. HTTP Event Server
CGI Event	The CGI trigger message	1. Relay 2. Email 3. FTP 4. HTTP Event Server 5. Record video on HDD
Sequential Snapshot	Enable sequential snapshot	Email FTP

Basic

Event Alarm Basic Settings

Alarm Time Interval

Delay second(s) before detecting the next alarm

Send Alarm with Snapshot images

Take snapshot in seconds(s) before event

Take snapshot in seconds(s) after event

Suffix of Image File Name in FTP and Mail attachment

With Data and Time

With Customized words

DI, Relay Status

DI 1 : Low DI 2 : Low DI 3 : Low DI 4 : Low

Relay 1 : Close

Override Relay warning setting

Override Relay 1 warning setting

Save

Alarm Time Interval

Setting	Description	Default
Delay second(s) before detecting the next alarm	Set the minimum time interval before another event alarm is triggered.	32 seconds (10 to 999 seconds)

NOTE The delay before triggering the next alarm cannot be less than the time needed to take a snapshot after an event (post-event image).

Send Alarm with Snapshot images

Setting	Description	Default
Take snapshot seconds(s) before the event	A snapshot image is taken this number of seconds before the event alarm is triggered.	2 seconds (from 1 to 6 seconds)
Take snapshot seconds(s) after the event	A snapshot image is taken this number of seconds after the event alarm is triggered.	11 seconds (from 1 to 999 seconds)

NOTE MxNVR-MO4 products will take 3 JPEG snapshot images: VPRE.JPG (pre-event), VTRG.JPG (the moment of event) and VPOS.JPG (post-event) for the video channel when the trigger condition is met. The three snapshots can also be downloaded by Email and FTP.

Suffix of Image File Name in FTP and Mail attachment

The snapshot images can be sent either by email or FTP. Administrators can add a suffix to the filename of each JPEG snapshot image to make it easier to identify the files when using FTP to download the snapshots.

Setting	Description	Default
With Date and Time	Enable or disable adding the date and time to the filename.	Disable
With Customized words	Enable or disable adding some additional custom text to the filename to identify the snapshot image.	Disable

DI, Relay Status

Administrators can check the current DI and Relay status of the MxNVR-MO4 in the “DI, Relay Status” section on the “Event Alarm Basic Settings” page. Two options are available to return the relay’s status back to the system defaults. To enable the function, select the **Override Relay 1 warning** setting and then click **Save**.

NOTE The relays will not be triggered when the Override Relay 1 warning setting and Override Relay 2 warning setting boxes are checked. Un-check these 2 boxes to ensure that the relays will trigger.

Schedule

A schedule is provided to set event alarms for daily security applications.

Event Type

Setting	Description	Default
Video Loss, Digital Input, CGI Event, and Sequential Snapshot	Set up the schedule of each kind of event type.	Video Loss

Weekly Schedule

Setting	Description	Default
Event Alarms are active all the time	Select the option “Event Alarms are active all the time”	Event Alarms are active based on a weekly schedule
Event Alarms are active based on a weekly schedule	Select to operate event alarms on a weekly schedule.	

NOTE The applications described in the following sections will only work properly if either Event Alarms are active all the time or Event Alarms are active based on weekly schedule is Selected.

Setting	Description	Default
<input type="checkbox"/> Sun <input type="checkbox"/> Mon <input type="checkbox"/> Tue <input type="checkbox"/> Wed <input type="checkbox"/> Thu <input type="checkbox"/> Fri <input type="checkbox"/> Sat	Select the weekday for scheduling event alarms.	None
Begin 00:00	Set the start time of the event alarm.	00:00
Duration 00:00	Set the duration for the event alarm to be active.	00:00

NOTE Administrators can use the following steps to set up an event schedule:

1. Select Event Type
2. Enable “Event Alarms are active based on weekly schedule”
3. Select the weekday
4. Set the start time
5. Set the duration this event will be active.
6. Save

Video Motion Detection

Video Motion Detection (VMD) is an intelligent event alarm for video surveillance network systems. With the 3 area-selectable VMDs and sensitivity/percentage tuning, administrators can easily set up the VMD alarm to be active 24 hours a day, 7 days a week.

VMD (Video Motion Detection)

- Enable VMD alarm
- Show alert on the image when VMD is triggered

Channel Selection

- Channel 1
- Channel 2
- Channel 3
- Channel 4

Set up VMD Alarm

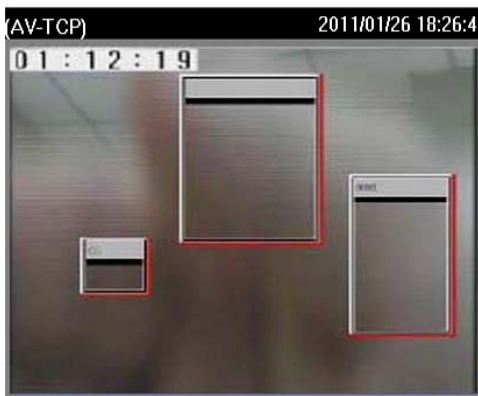

EnableWindow	Percent
<input type="checkbox"/> VMD[] [80]
<input type="checkbox"/> VMD[] [80]
<input type="checkbox"/> VMD[] [80]
Sensitive	
	1
<input type="button" value="Save"/>	

Trigger Conditions and Actions

Trigger Condition	Trigger Action	HTTP Action Setting
VMD1	<input type="checkbox"/> Trigger Relay1 alarm <input type="checkbox"/> Send snapshot image via E-mail <input type="checkbox"/> Send snapshot image via FTP <input type="checkbox"/> Send message via HTTP Event Servers <input type="checkbox"/> Record video on HDD 5 Sec.	<input type="checkbox"/> Server1 <input type="checkbox"/> Server2 <input type="checkbox"/> Server3 <input type="checkbox"/> Server4
VMD2	<input type="checkbox"/> Trigger Relay1 alarm <input type="checkbox"/> Send snapshot image via E-mail <input type="checkbox"/> Send snapshot image via FTP <input type="checkbox"/> Send message via HTTP Event Servers <input type="checkbox"/> Record video on HDD 5 Sec.	<input type="checkbox"/> Server1 <input type="checkbox"/> Server2 <input type="checkbox"/> Server3 <input type="checkbox"/> Server4
VMD3	<input type="checkbox"/> Trigger Relay1 alarm <input type="checkbox"/> Send snapshot image via E-mail <input type="checkbox"/> Send snapshot image via FTP <input type="checkbox"/> Send message via HTTP Event Servers <input type="checkbox"/> Record video on HDD 5 Sec.	<input type="checkbox"/> Server1 <input type="checkbox"/> Server2 <input type="checkbox"/> Server3 <input type="checkbox"/> Server4

Note: HTTP Action Setting allows the VPort sending the customized alarm messages to the HTTP Event Server when the event is triggered. Please refer to URL syntax being defined in RFC 1738 and the customer-defined commands for writing this setting with 100 characters.

Setting	Description	Default
Enable VMD alarm	Enable or disable the Video Motion Detection alarm	Disabled
Show alert on the image when VMD is triggered	Enable or disable the "show the alert," which when enabled displays a red square frame on the video image of the VMD alarm notification	Disabled
Channel Selection	Select Channel 1, 2, 3, or 4 to setup the VMD alarm	Channel 1

NOTE Once the Show alert on the image when VMD is triggered is enabled, the red frames that appear on the homepage image indicate the size of the VMD window set up by the administrator.

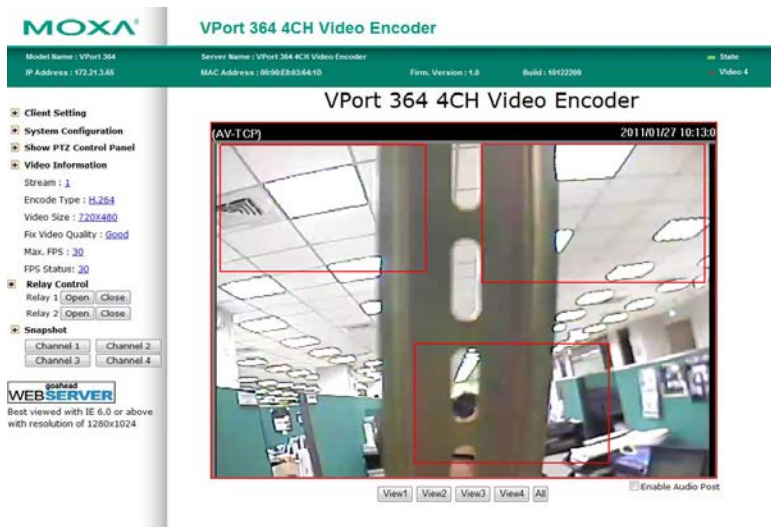

Set up VMD Alarm



Setup a VMD Alarm

Setting	Description	Default
Enable	Enable or disable the VMD1, 2, and 3	Disabled
Window	The name of each VMD window	Blank
Percent	The minimum percentage of an image change for triggering VMD. Decrease the percentage to make it easier to trigger VMD.	80
Sensitive	The measurable difference between two sequential images for triggering VMD. Increase the sensitivity to make it easier for VMD to be triggered.	1

NOTE After setting the VMD Alarm, click the **Save** button to save the changes.

Trigger Conditions and Actions

Administrators can set triggers, such as Trigger Relay1 alarm, Send snapshot image via E-mail, Send snapshot image via FTP, Send Message via HTTP Event servers, and Record video on HDD, for each VMD.

Setting	Description	Default
Trigger Relay1 alarm	Once this DI is triggered, the Relay1 alarm will be activated	Disabled
Trigger Relay2 alarm	Once this DI is triggered, the Relay2 alarm will be activated	Disabled
Send snapshot image via E-mail	Once this VMD is triggered, the MxNVR-MO4 will send the snapshot images set in the Event Alarm/Basic page to the E-mail addresses, which are set in the Network/ SMTP Server page.	Disabled
Send snapshot image via FTP	Once this VMD is triggered, the MxNVR-MO4 will send the snapshot images set in the Event Alarm/Basic page to the FTP server, which are set in the Network/ FTP Server page.	Disabled
Send message via HTTP Event Servers	Once this VMD is triggered, the MxNVR-MO4 will send the message set in HTTP Action Setting to the HTTP event servers, which are set in the Network/ HTTP Event Server page.	Disabled
Record video on HDD for <input type="text"/> Sec	Once this VMD is triggered, the MxNVR-MO4 will record the video on the HDD for a configured time period.	Disabled

HTTP Action Setting

Setting	Description	Default
Server 1, 2, 3, or 4	Select the HTTP event server for sending the HTTP action	Disabled
Blank text box	For customizing the message to the HTTP event server.	Blank

Digital Input

Four digital inputs are provided by the MxNVR-MO4 for linking with alarm detection devices, such as sensors.

Digital Inputs

Enable digital input alarm

Trigger Conditions and Actions

Trigger Condition	Trigger Action	HTTP Action Setting	Snapshot Image	Record Channel
<input type="radio"/> High <input checked="" type="radio"/> Low <input type="radio"/> Rising <input type="radio"/> Falling	<input type="checkbox"/> Trigger Relay1 alarm	<input type="checkbox"/> Server1 <input type="checkbox"/> Server2 <input type="checkbox"/> Server3 <input type="checkbox"/> Server4	<input type="checkbox"/> Channel 1 <input type="checkbox"/> Channel 2 <input type="checkbox"/> Channel 3 <input type="checkbox"/> Channel 4	<input type="checkbox"/> Channel 1 <input type="checkbox"/> Channel 2 <input type="checkbox"/> Channel 3 <input type="checkbox"/> Channel 4
	<input type="checkbox"/> Send snapshot image via E-mail			
	<input type="checkbox"/> Send snapshot image via FTP			
	<input type="checkbox"/> Send message via HTTP Event Servers			
	<input type="checkbox"/> Record video on HDD 5 <input type="text"/> Sec.			
<input type="radio"/> High <input checked="" type="radio"/> Low <input type="radio"/> Rising <input type="radio"/> Falling	<input type="checkbox"/> Trigger Relay1 alarm	<input type="checkbox"/> Server1 <input type="checkbox"/> Server2 <input type="checkbox"/> Server3 <input type="checkbox"/> Server4	<input type="checkbox"/> Channel 1 <input type="checkbox"/> Channel 2 <input type="checkbox"/> Channel 3 <input type="checkbox"/> Channel 4	<input type="checkbox"/> Channel 1 <input type="checkbox"/> Channel 2 <input type="checkbox"/> Channel 3 <input type="checkbox"/> Channel 4
	<input type="checkbox"/> Send snapshot image via E-mail			
	<input type="checkbox"/> Send snapshot image via FTP			
	<input type="checkbox"/> Send message via HTTP Event Servers			
	<input type="checkbox"/> Record video on HDD 5 <input type="text"/> Sec.			
<input type="radio"/> High <input checked="" type="radio"/> Low <input type="radio"/> Rising <input type="radio"/> Falling	<input type="checkbox"/> Trigger Relay1 alarm	<input type="checkbox"/> Server1 <input type="checkbox"/> Server2 <input type="checkbox"/> Server3 <input type="checkbox"/> Server4	<input type="checkbox"/> Channel 1 <input type="checkbox"/> Channel 2 <input type="checkbox"/> Channel 3 <input type="checkbox"/> Channel 4	<input type="checkbox"/> Channel 1 <input type="checkbox"/> Channel 2 <input type="checkbox"/> Channel 3 <input type="checkbox"/> Channel 4
	<input type="checkbox"/> Send snapshot image via E-mail			
	<input type="checkbox"/> Send snapshot image via FTP			
	<input type="checkbox"/> Send message via HTTP Event Servers			
	<input type="checkbox"/> Record video on HDD 5 <input type="text"/> Sec.			
<input type="radio"/> High <input checked="" type="radio"/> Low <input type="radio"/> Rising <input type="radio"/> Falling	<input type="checkbox"/> Trigger Relay1 alarm	<input type="checkbox"/> Server1 <input type="checkbox"/> Server2 <input type="checkbox"/> Server3 <input type="checkbox"/> Server4	<input type="checkbox"/> Channel 1 <input type="checkbox"/> Channel 2 <input type="checkbox"/> Channel 3 <input type="checkbox"/> Channel 4	<input type="checkbox"/> Channel 1 <input type="checkbox"/> Channel 2 <input type="checkbox"/> Channel 3 <input type="checkbox"/> Channel 4
	<input type="checkbox"/> Send snapshot image via E-mail			
	<input type="checkbox"/> Send snapshot image via FTP			
	<input type="checkbox"/> Send message via HTTP Event Servers			
	<input type="checkbox"/> Record video on HDD 5 <input type="text"/> Sec.			

Note: HTTP Action Setting allows the VPort sending the customized alarm messages to the HTTP Event Server when the event is triggered. Please refer to URL syntax being defined in RFC 1738 and the customer-defined commands for writing this setting with 100 characters.

Setting	Description	Default
Enable digital input alarm	Enable or disable the digital input alarm.	Disable

Trigger Conditions

Setting	Description	Default
High	The DI is always in the "High" state after an alarm is detected.	Disable
Low	The DI is always in the "Low" state after an alarm is detected.	Enable
Rising	The DI works from state "Low" to state "High" and then back to state "Low" when an alarm is detected.	Disable
Falling	The DI works from state "High" to state "Low" and then back to state "High" when an alarm is detected.	Disable

NOTE Please refer to Chapter 1 to see the DI specifications.

Trigger Actions

Setting	Description	Default
Trigger Relay1 alarm	Once this DI is triggered, the Relay1 alarm will be activated	Disable
Send snapshot image via E-mail	Once this DI is triggered, the MxNVR-MO4 will send the snapshot images set in the Event Alarm/Basic page to the E-mail addresses, which are set in the Network/SMTP Server page.	Disable
Send snapshot image via FTP	Once this DI is triggered, the MxNVR-MO4 will send the snapshot images set in the Event Alarm/Basic page to the FTP server, which are set in the Network/ FTP Server page.	Disable
Send message via HTTP Event Servers	Once this DI is triggered, the MxNVR-MO4 will send the message set in HTTP Action Setting to the HTTP event servers, which are set in the Network/ HTTP Event Server page.	Disable
Record video on HDD for <input type="checkbox"/> Sec	Once this DI is triggered, the MxNVR-MO4 will record the video on the HDD for a configured time period.	Disabled

HTTP Action Setting

Setting	Description	Default
Server 1, 2, 3, 4	Select the HTTP event server for sending the HTTP action	Disable
Blank column	Administrators can customize the message sent to the HTTP event sever in this column	Blank

Setting	Description	Default
Snapshot image	Select the video channel which will send out the snapshot image once the DI is triggered	Disable
Record Channel	Select the video channel which will record the video once the DI is triggered	Disable

Video Loss

The Video Loss event means that the MxNVR-MO4 cannot detect the analog video signal.

Video Loss

Enable video loss alarm

Video Loss Trigger Actions

Channel	Trigger Action	HTTP Action Setting
Channel 1	<input type="checkbox"/> Trigger Relay1 alarm <input type="checkbox"/> Send snapshot image via E-mail <input type="checkbox"/> Send snapshot image via FTP <input type="checkbox"/> Send message via HTTP Event Servers <input type="checkbox"/> Record video on HDD <input type="text" value="5"/> Sec.	<input type="checkbox"/> Server1 <input type="checkbox"/> Server2 <input type="checkbox"/> Server3 <input type="checkbox"/> Server4 <div style="border: 1px solid #ccc; height: 40px; width: 100%;"></div>
Channel 2	<input type="checkbox"/> Trigger Relay1 alarm <input type="checkbox"/> Send snapshot image via E-mail <input type="checkbox"/> Send snapshot image via FTP <input type="checkbox"/> Send message via HTTP Event Servers <input type="checkbox"/> Record video on HDD <input type="text" value="5"/> Sec.	<input type="checkbox"/> Server1 <input type="checkbox"/> Server2 <input type="checkbox"/> Server3 <input type="checkbox"/> Server4 <div style="border: 1px solid #ccc; height: 40px; width: 100%;"></div>
Channel 3	<input type="checkbox"/> Trigger Relay1 alarm <input type="checkbox"/> Send snapshot image via E-mail <input type="checkbox"/> Send snapshot image via FTP <input type="checkbox"/> Send message via HTTP Event Servers <input type="checkbox"/> Record video on HDD <input type="text" value="5"/> Sec.	<input type="checkbox"/> Server1 <input type="checkbox"/> Server2 <input type="checkbox"/> Server3 <input type="checkbox"/> Server4 <div style="border: 1px solid #ccc; height: 40px; width: 100%;"></div>
Channel 4	<input type="checkbox"/> Trigger Relay1 alarm <input type="checkbox"/> Send snapshot image via E-mail <input type="checkbox"/> Send snapshot image via FTP <input type="checkbox"/> Send message via HTTP Event Servers <input type="checkbox"/> Record video on HDD <input type="text" value="5"/> Sec.	<input type="checkbox"/> Server1 <input type="checkbox"/> Server2 <input type="checkbox"/> Server3 <input type="checkbox"/> Server4 <div style="border: 1px solid #ccc; height: 40px; width: 100%;"></div>

Note: HTTP Action Setting allows the VPort sending the customized alarm messages to the HTTP Event Server when the event is triggered. Please refer to I/O entry being defined in SEC 4.7.3.8 and the customer defined commands for writing this setting with 400 characters.

Video Loss Trigger Actions

Setting	Description	Default
Enable video loss alarm	Enable or disable video loss alarm.	Disable
Trigger Relay1 alarm	Once the Video Loss alarm is triggered, the Relay1 alarm will be activated.	Disable
Send snapshot image via FTP	Once the Video Loss alarm is triggered, the MxNVR-MO4 will send the snapshot images set in the Event Alarm/Basic page to the FTP server, which are set in the Network/FTP Server page.	Disable
Send message via HTTP Event Servers	Once the Video Loss alarm is triggered, the MxNVR-MO4 will send the message set in the HTTP Action Setting to the HTTP event servers, which are set in the Network/ HTTP Event Server page.	Disable
Record video on HDD for <input type="text" value="5"/> Sec	Once this Video Loss is triggered, the MxNVR-MO4 will record the video on the HDD for a configured time period.	Disabled

HTTP Action Setting

Setting	Description	Default
Server 1, 2, 3, 4	Select the HTTP event server for sending the HTTP action.	Disable
Blank column	Administrators can customize the message sent to the HTTP event sever in this column.	Blank

CGI Event

The MxNVR-MO4 can accept 5 CGI commands, which are sent from external devices, such as iologik series Ethernet I/O, to be the event alarms.

NOTE The MxNVR-MO4 only can accept the CGI commands that follow the MxNVR-MO4's CGI commands format.

CGI Event

Enable CGI Event alarm

CGI Event Trigger Actions

Event Index	Trigger Action	HTTP Action Setting	Snapshot Image	Record Channel
Event 1	<input type="checkbox"/> Trigger Relay1 alarm	<input type="checkbox"/> Server1 <input type="checkbox"/> Server2 <input type="checkbox"/> Server3 <input type="checkbox"/> Server4	<input type="checkbox"/> Channel 1	<input type="checkbox"/> Channel 1
	<input type="checkbox"/> Send snapshot image via E-mail	[Empty Message Field]	<input type="checkbox"/> Channel 2	<input type="checkbox"/> Channel 2
	<input type="checkbox"/> Send snapshot image via FTP		<input type="checkbox"/> Channel 3	<input type="checkbox"/> Channel 3
	<input type="checkbox"/> Send message via HTTP Event Servers		<input type="checkbox"/> Channel 4	<input type="checkbox"/> Channel 4
	<input type="checkbox"/> Record video on HDD 5 Sec.			
Event 2	<input type="checkbox"/> Trigger Relay1 alarm	<input type="checkbox"/> Server1 <input type="checkbox"/> Server2 <input type="checkbox"/> Server3 <input type="checkbox"/> Server4	<input type="checkbox"/> Channel 1	<input type="checkbox"/> Channel 1
	<input type="checkbox"/> Send snapshot image via E-mail	[Empty Message Field]	<input type="checkbox"/> Channel 2	<input type="checkbox"/> Channel 2
	<input type="checkbox"/> Send snapshot image via FTP		<input type="checkbox"/> Channel 3	<input type="checkbox"/> Channel 3
	<input type="checkbox"/> Send message via HTTP Event Servers		<input type="checkbox"/> Channel 4	<input type="checkbox"/> Channel 4
	<input type="checkbox"/> Record video on HDD 5 Sec.			
Event 3	<input type="checkbox"/> Trigger Relay1 alarm	<input type="checkbox"/> Server1 <input type="checkbox"/> Server2 <input type="checkbox"/> Server3 <input type="checkbox"/> Server4	<input type="checkbox"/> Channel 1	<input type="checkbox"/> Channel 1
	<input type="checkbox"/> Send snapshot image via E-mail	[Empty Message Field]	<input type="checkbox"/> Channel 2	<input type="checkbox"/> Channel 2
	<input type="checkbox"/> Send snapshot image via FTP		<input type="checkbox"/> Channel 3	<input type="checkbox"/> Channel 3
	<input type="checkbox"/> Send message via HTTP Event Servers		<input type="checkbox"/> Channel 4	<input type="checkbox"/> Channel 4
	<input type="checkbox"/> Record video on HDD 5 Sec.			
Event 4	<input type="checkbox"/> Trigger Relay1 alarm	<input type="checkbox"/> Server1 <input type="checkbox"/> Server2 <input type="checkbox"/> Server3 <input type="checkbox"/> Server4	<input type="checkbox"/> Channel 1	<input type="checkbox"/> Channel 1
	<input type="checkbox"/> Send snapshot image via E-mail	[Empty Message Field]	<input type="checkbox"/> Channel 2	<input type="checkbox"/> Channel 2
	<input type="checkbox"/> Send snapshot image via FTP		<input type="checkbox"/> Channel 3	<input type="checkbox"/> Channel 3
	<input type="checkbox"/> Send message via HTTP Event Servers		<input type="checkbox"/> Channel 4	<input type="checkbox"/> Channel 4
	<input type="checkbox"/> Record video on HDD 5 Sec.			
Event 5	<input type="checkbox"/> Trigger Relay1 alarm	<input type="checkbox"/> Server1 <input type="checkbox"/> Server2 <input type="checkbox"/> Server3 <input type="checkbox"/> Server4	<input type="checkbox"/> Channel 1	<input type="checkbox"/> Channel 1
	<input type="checkbox"/> Send snapshot image via E-mail	[Empty Message Field]	<input type="checkbox"/> Channel 2	<input type="checkbox"/> Channel 2
	<input type="checkbox"/> Send snapshot image via FTP		<input type="checkbox"/> Channel 3	<input type="checkbox"/> Channel 3

CGI Event Trigger Actions

Setting	Description	Default
Enable CGI Event alarm	Enable or disable CGI Event alarm.	Disable
Event	Select the Event 1, 2, 3, 4, 5	Disable
Trigger Relay1 alarm	Once this CGI Event is triggered, the Relay1 alarm will be activated	Disable
Send snapshot image via FTP	Once this CGI Event is triggered, the MxNVR-MO4 will send the snapshot images set in the Event Alarm/Basic page to the FTP server, which are set in the Network/ FTP Server page.	Disable
Send message via HTTP Event Servers	Once this CGI Event is triggered, the MxNVR-MO4 will send the message set in the HTTP Action Setting to the HTTP event servers, which are set in the Network/ HTTP Event Server page.	Disable
Record video on HDD for []Sec	Once this Video Loss is triggered, the MxNVR-MO4 will record the video on the HDD for a configured time period.	Disabled

HTTP Action Setting

Setting	Description	Default
Server 1, 2, 3, 4	Select the HTTP event server for sending the HTTP action	Disable
Blank column	Administrators can customize the message sent to the HTTP event sever in this column	Blank

Setting	Description	Default
Snapshot image	Select the video channel which will send out the snapshot image once the Video Loss is triggered	Disable
Record Channel	Select the video channel which will record the video once the Video Loss is triggered	Disable

Sequential Snapshot

With this feature, the MxNVR-MO4 can upload snapshots periodically to an external E-mail or FTP server as a live video source. Use the Send sequential snapshot image every seconds option to set the time interval. The interval can be set to any number between 1 and 9999 seconds.

Setting	Description	Default
Enable Sequential Snapshots	Enable or disable the Sequential Snapshots.	Disable
Send sequential snapshot image every seconds	Set the time interval of each snapshot image.	30 seconds (from 1 second to 30 seconds)
Send Snapshot image via E-mail	Choose how to send the snapshot images.	Send Snapshot image via Email
Send Snapshot image via FTP		

Sequential Snapshots

Channel Select	Send Interval(Sec.)	Send Method
<input type="checkbox"/> Channel 1	Send sequential snapshot image every 30 [1~30] second(s)	<input checked="" type="radio"/> Send snapshot image via E-mail <input type="radio"/> Send snapshot image via FTP
<input type="checkbox"/> Channel 2	Send sequential snapshot image every 30 [1~30] second(s)	<input checked="" type="radio"/> Send snapshot image via E-mail <input type="radio"/> Send snapshot image via FTP
<input type="checkbox"/> Channel 3	Send sequential snapshot image every 30 [1~30] second(s)	<input checked="" type="radio"/> Send snapshot image via E-mail <input type="radio"/> Send snapshot image via FTP
<input type="checkbox"/> Channel 4	Send sequential snapshot image every 30 [1~30] second(s)	<input checked="" type="radio"/> Send snapshot image via E-mail <input type="radio"/> Send snapshot image via FTP

Save

Frequently Asked Questions

FAQ 1: What if I forget my password?

Every access to the video recorder needs authentication, unless the admin password is set up as blank. If you are one of the managed users, you will need to ask the administrator for the password. If you are the administrator, there is no way to recover the admin password. The only way to regain access to video recorder is to utilize the **RESET** button on the top panel to restore the factory settings (see Chapter 1 for details).

FAQ 2: Why can't I see video from the video recorder after it has been authenticated?

There are many possible scenarios:

If you have just installed the video recorder and are unable to see the video, check the video modulation on the **System Configuration\Video\Camera Modulation** page.

If the video recorder is installed correctly and you are accessing the video recorder for the first time using Internet Explorer, adjust the security level of Internet Explorer to allow installation of plug-ins.

If the problem still exists, the number of users accessing the video recorder at the same time may exceed the maximum that the system allows.

FAQ 3: What is the plug-in for?

The plug-in provided by video recorder is used to display motion pictures. The plug-in is needed because Internet Explorer does not support streaming technology. If your system does not allow installation of plug-in software, the security level of the web browser may need to be lowered. It is recommended that you consult the network supervisor in your office before adjusting the security level.

FAQ 4: Why is the timestamp different from the system time of my PC or notebook?

The timestamp is based on the system time of the video recorder. It is maintained by an internal real-time clock, and automatically synchronizes with the time server if the video recorder is connected to the Internet and the function is enabled. Differences of several hours may result from the time zone setting.

FAQ 5: Why doesn't the image refresh regularly?

This may be due to the time it takes to store recorded video and snapshots into memory, or the time it takes to send the images to the SMTP and FTP server when events occur.

FAQ 6: How many users are allowed to access the video recorder at the same time?

Basically, there is no limitation. However the video quality also depends on the network. To achieve the best effect, the MxNVR-MO4 video recorder will allow 8 video streams for udp/tcp/http connections, and 4 multicast video streams. We recommend using an additional web server that retrieves images from the video recorder periodically if you need to host a large number of users.

FAQ 7: What is the video recorder's video rate?

Each H.264 and MJPEG channel can process 30 frames per second. If dual streaming, using both H.264 and MJPEG format, is enabled, then the total FPS is 30. Note that video performance may be affected by a variety of variables, such as:

1. Network throughput.
2. Bandwidth share.

3. Number of users.
4. More complicated objects result in larger image files.
5. The speed of the PC or notebook that is responsible for displaying images.

FAQ 7: How can I keep the video recorder as private as possible?

The video recorder is designed for surveillance purposes and has many flexible interfaces. The user authentication and special confirmation when installing can keep the video recorder from unauthorized access. You may also change the HTTP port to a non-public number. Check the system log to examine any abnormal activities and trace the origins.

FAQ 8: How fast will the video recorder check the status of digital inputs?

The video recorder will check the input status in less than half a second.

FAQ 9: Why can't I access the video recorder when I set up some options in the application?

When the video recorder is triggered by events, video and snapshots will take more time to write to memory. If the events occur too often, the system will always be busy storing video and images. We recommend using sequential mode or an external recorder program to record motion pictures if the event is frequent. If you prefer to retrieve images by FTP, the value could be smaller since an FTP server responds more quickly than a web server. Once the system is too busy to configure, use the restore factory default and reset button to save the system.

B

ModBus Address Table

Read Only Registers (Support Function Code 4, 3)

Address	Access	Data Type	Description
System Information			
0x0000	R	1 word	Vendor ID = 0x1393
0x0001	R	1 word	Unit ID (Ethernet = 1)
0x0002	R	1 word	Product Code = Magic Code(2 byte)
0x0010	R	20 word	Vendor Name = "Moxa" Word 0 Hi byte = 'M' Word 0 Lo byte = 'o' Word 1 Hi byte = 'x' Word 1 Lo byte = 'a' Word 2 Hi byte = '\0' Word 2 Lo byte = '\0'
0x0030	R	20 word	Product Name = "MxNVR-MO4 " Word 0 Hi byte = 'M' Word 0 Lo byte = 'X' Word 1 Hi byte = 'N' Word 1 Lo byte = 'V' Word 2 Hi byte = 'R' Word 2 Lo byte = '-' Word 3 Hi byte = 'M' Word 3 Lo byte = 'O' Word 4 Hi byte = '4' Word 4 Lo byte = '\0'
0x0050	R	1 word	Product Serial Number
0x0051	R	2 word	Firmware Version Word 0 Hi byte = major (A) Word 0 Lo byte = minor (B) Word 1 Hi byte = release (C) Word 1 Lo byte = build (D)
0x0053	R	2 word	Firmware Release Date Firmware was released on 2007-05-06 at 09 o'clock Word 0 = 0x0609 Word 1 = 0x0705
0x0055	R	3 word	Ethernet MAC Address Ex: MAC = 00-01-02-03-04-05 Word 0 Hi byte = 0x00 Word 0 Lo byte = 0x01 Word 1 Hi byte = 0x02 Word 1 Lo byte = 0x03 Word 2 Hi byte = 0x04 Word 2 Lo byte = 0x05

0x0058 88	R	1 word	Power 1 0x0000: Off 0x0001: On
0x0059	R	1 word	Power 2 0x0000: Off 0x0001: On
0x005A	R	1 word	Fault LED Status 0x0000: No 0x0001: Yes
0x005B	R	1 word	Channel 1 Video Signal 0x0000: Off 0x0001: On
0x005C	R	1 word	Channel 2 Video Signal 0x0000: Off 0x0001: On
0x005D	R	1 word	Channel 3 Video Signal 0x0000: Off 0x0001: On
0x005E	R	1 word	Channel 4 Video Signal 0x0000: Off 0x0001: On
0x0080	R	1 word	DI1 0x0000: Off 0x0001: On
0x0081	R	1 word	DI2 0x0000: Off 0x0001: On
0x0082	R	1 word	DI3 0x0000: Off 0x0001: On
0x0083	R	1 word	DI4 0x0000: Off 0x0001: On
0x0088	R/W	1 word	DO1 0x0000: Open 0x0001: Close
0x0089	R/W	1 word	DO2 0x0000: Open 0x0001: Close
DynaStream			
0x800	R/W	1 word	CH1 DynaStream Duration 1~999
0x801	R/W	1 word	CH1 DynaStream alwaysrun/forcestop 1: Always Run 0: Force Stop
0x802	R/W	1 word	CH2 DynaStream Duration 1~999
0x803	R/W	1 word	CH2 DynaStream alwaysrun/forcestop 1: Always Run 0: Force Stop
0x804	R/W	1 word	CH3 DynaStream Duration 1~999

0x805	R/W	1 word	CH3 DynaStream alwaysrun/forcestop 1: Always Run 0: Force Stop
0x806	R/W	1 word	CH4 DynaStream Duration 1~999
0x807	R/W	1 word	CH4 DynaStream alwaysrun/forcestop 1: Always Run 0: Force Stop
Port Information			
0x1000		1 word	Port 1 Status 0x0000: Link down 0x0001: Link up 0x0002: Disable 0xFFFF: No port
0x1001		1 word	Port 2 Status 0x0000: Link down 0x0001: Link up 0x0002: Disable 0xFFFF: No port

C

Time Zone Table

The hour offsets for different time zones are shown below. You will need this information when setting the time zone in automatic date/time synchronization. GMT stands for Greenwich Mean Time, which is the global time that all time zones are measured from.

(GMT-12:00)	International Date Line West
(GMT-11:00)	Midway Island, Samoa
(GMT-10:00)	Hawaii
(GMT-09:00)	Alaska
(GMT-08:00)	Pacific Time (US & Canada), Tijuana
(GMT-07:00)	Arizona
(GMT-07:00)	Chihuahua, La Paz, Mazatlan
(GMT-07:00)	Mountain Time (US & Canada)
(GMT-06:00)	Central America
(GMT-06:00)	Central Time (US & Canada)
(GMT-06:00)	Guadalajara, Mexico City, Monterrey
(GMT-06:00)	Saskatchewan
(GMT-05:00)	Bogota, Lima, Quito
(GMT-05:00)	Eastern Time (US & Canada)
(GMT-05:00)	Indiana (East)
(GMT-04:00)	Atlantic Time (Canada)
(GMT-04:00)	Caracas, La Paz
(GMT-04:00)	Santiago
(GMT-03:30)	Newfoundland
(GMT-03:00)	Brasilia
(GMT-03:00)	Buenos Aires, Georgetown
(GMT-03:00)	Greenland
(GMT-02:00)	Mid-Atlantic
(GMT-01:00)	Azores
(GMT-01:00)	Cape Verde Is.
(GMT)	Casablanca, Monrovia
(GMT)	Greenwich Mean Time: Dublin, Edinburgh, Lisbon, London
(GMT+01:00)	Amsterdam, Berlin, Bern, Stockholm, Vienna
(GMT+01:00)	Belgrade, Bratislava, Budapest, Ljubljana, Prague (GMT+01 :00) Brussels, Copenhagen, Madrid, Paris
(GMT+01:00)	Sarajevo, Skopje, Warsaw, Zagreb
(GMT+01:00)	West Central Africa
(GMT+02:00)	Athens, Istanbul, Minsk
(GMT+02:00)	Bucharest
(GMT+02:00)	Cairo
(GMT+02:00)	Harare, Pretoria
(GMT+02:00)	Helsinki, Kyiv, Riga, Sofia, Tallinn, Vilnius
(GMT+02:00)	Jerusalem
(GMT+03:00)	Baghdad
(GMT+03:00)	Kuwait, Riyadh
(GMT+03:00)	Moscow, St. Petersburg, Volgograd

(GMT+03:00)	Nairobi
(GMT+03:30)	Tehran
(GMT+04:00)	Abu Dhabi, Muscat (GMT+04:00) Baku, Tbilisi, Yerevan (GMT+04:30) Kabul
(GMT+05:00)	Ekaterinburg
(GMT+05:00)	Islamabad, Karachi, Tashkent (GMT+05:30) Chennai, Kolkata, Mumbai, New Delhi
(GMT+05:45)	Kathmandu
(GMT+06:00)	Almaty, Novosibirsk (GMT+06:00) Astana, Dhaka
(GMT+06:00)	Sri Jayawardenepura (GMT+06:30) Rangoon
(GMT+07:00)	Bangkok, Hanoi, Jakarta (GMT+07:00) Krasnoyarsk
(GMT+08:00)	Beijing, Chongqing, Hong Kong, Urumqi
(GMT+08:00)	Taipei
(GMT+08:00)	Irkutsk, Ulaan Bataar (GMT+08:00) Kuala Lumpur, Singapore
(GMT+08:00)	Perth
(GMT+09:00)	Osaka, Sapporo, Tokyo (GMT+09:00) Seoul
(GMT+09:00)	Yakutsk
(GMT+09:30)	Adelaide
(GMT+09:30)	Darwin
(GMT+10:00)	Brisbane
(GMT+10:00)	Canberra, Melbourne, Sydney
(GMT+10:00)	Guam, Port Moresby (GMT+10:00) Hobart
(GMT+10:00)	Vladivostok
(GMT+11:00)	Magadan, Solomon Is., New Caledonia
(GMT+12:00)	Auckland, Wellington (GMT+ 12:00) Fiji, Kamchatka, Marshall Is.
(GMT+13:00)	Nuku'alofa

Technical Specifications

Video

Video Compression: H.264 (MPEG4 part 10, AVC) or MJPEG

Video Inputs: 4, BNC connector (1.0 Vpp, 75 ohm)

Video Streams: Dual streams (one for H.264, the other for MJPEG)

NTSC/PAL: Manual

Video Resolution and FPS (frames per second) in single video stream:

	NTSC		PAL	
	Size	Max. FPS	Size	Max. FPS
QCIF	176 x 112	30	176 x 144	25
CIF	352 x 240	30	352 x 288	25
VGA	640 x 480	30	640 x 480	25
4CIF	704 x 480	30	704 x 576	25
Full D1	720 x 480	30	720 x 576	25

* When enabling simultaneous H.264 and MJPEG video streaming at Full D1 resolution, the total FPS of these 2 video streams will be about 30 FPS. For example, if the MJPEG stream is set to 10 FPS, then the H.264 stream must be set to 20 FPS.

* 4 channels of the MJPEG video streaming support up to VGA, 4CIF and Full D1 resolution at 60 FPS (including pre-event JPEG snapshot image).

Video Viewing:

- DynaStream supported for changing the video frame rate automatically
- Adjustable image size and quality
- Timestamp and text overlay
- Maximum of 8 simultaneous unicast connections

Recording

Stream Types: H.264 @ 120 FPS or MJPEG @ 60 FPS

Video File Format: AVI

Record Modes: continuous recording, schedule recording, event recording

Searching

Search Modes: By camera, by event and time (A customized software is required)

Playback Methods: Playback with popular media players (such as VLC)

Video Clips Download: Remote download via FTP

Storage

Disk Interface: 1 SATA interface for 2.5-inch hard disk or SSD (solid state disk)

Disk Tray: Removable disk tray

* The 2.5-inch hard disk and SSD need to be purchased and installed by the user.

Audio

Audio Inputs: 2, Line-in or MIC-in, DB9 connector

Audio Format: Mono, PCM (G.711)

Network

Protocols: TCP, UDP, HTTP, SMTP, FTP, NTP, DNS, DHCP, UPnP, RTP, RTSP, ICMP, IGMPv3, QoS, SNMPv1/v2c/v3, DDNS, DHCP OPT66/67, Modbus/TCP, 802.1X

Ethernet: 1 10/100BaseT(X), 4-pin M12 D-code connector

Serial Port

Console Port: 1 RS-232 RJ45 port

GPIO

Digital Inputs: 4, max. 8 mA

Low: +13 to +30 V; High: -30 to +3 V

Relay Outputs: 1, max. 24 VDC @ 1 A

Connector: DB9, Male

LED Indicators

STAT: System status

PWR: Power on/off

HDD: Storage disk status

FAULT: Can be configured for network down

V1, V2, V3, V4: Video input signal activity for channels 1 to 4

Power Requirements

Input Voltage: 1, 12 VDC or 24 VDC input (12 to 32VDC)

Power Consumption: Approximately 11 Watt (with a 2.5-inch hard disk)

Connector: 4-pin M12 A-code connector

Physical Characteristics

Housing: Metal

Dimensions: 92.8 x 135 x 150.4 mm (3.93 x 5.31 x 5.35 in)

Weight: 1100 g

Installation: Panel mounting or DIN-rail mounting (The DIN-rail kit DK-DC50131 is optional)

Alarms

Video Motion Detection: Includes sensitivity tuning

Video Loss: Video loss alarm

Scheduling: Daily repeat timing schedule

Imaging: JPEG snapshots for pre/trigger/post alarm images

Email/FTP Messaging: Automatic transfer of stored images via email or FTP with event-triggered actions

Custom Alarms: HTTP event servers and CGI events for setting customized alarm actions

Pre-alarm Buffer: 16 MB per channel for JPEG snapshot images

Security

Password: User level password protection

Filtering: By IP address

Authentication: 802.1X

Environmental Limits

Operating Temperature:

Standard Models: 0 to 60°C (32 to 140°F)

Wide Temp. Models: -40 to 75°C (-40 to 167°F)

Storage Temperature: -40 to 85°C (-40 to 185°F)

Ambient Relative Humidity: 5 to 95% (non-condensing)

Standards and Certifications

Safety: UL60950-1

EMI: FCC Part 15 Subpart B Class A, EN 55022 Class A

EMS:

EN 61000-4-2 (ESD) Level 3,

EN 61000-4-3 (RS) Level 3,

EN 61000-4-4 (EFT) Level 3,

EN 61000-4-5 (Surge) Level 3,

EN 61000-4-6 (CS) Level 3,

EN 61000-4-8,

EN 61000-4-11

EN 50155:2007 (T model): Power characteristic, shock, vibration, temperature (TX temperature level), EMC

Vibration: EN/IEC 61373 (with Toshiba 2.5-inch hard disk)

Shock: EN/IEC 61373 (with Toshiba 2.5-inch hard disk)

Freefall: IEC60068-2-32

Warranty

Warranty Period: 5 years

Details: See www.moxa.com/warranty

Viewing System Requirements

CPU: Pentium 4, 2.4 GHz or above

Memory: 512 MB memory or above

OS: Windows XP/2000 with SP2 or above

Browser: Internet Explorer 6.x or above

Multimedia: DirectX 9.0c or above

Software Development Kit

MxNVR-MO4 SDK PLUS: Includes CGI commands, ActiveX Control, and API library for customized applications or system integration for third-party developers (the latest version of SDK is available for download from Moxa's website).

Standard: OnVIF