

IEX-408E-2VDSL2 Series Quick Installation Guide

Moxa Managed VDSL2 Ethernet Extender Switch

Edition 1.0, April 2016

Technical Support Contact Information **www.moxa.com/support**

Moxa Americas:

Toll-free: 1-888-669-2872

Tel: 1-714-528-6777

Fax: 1-714-528-6778

Moxa China (Shanghai office):

Toll-free: 800-820-5036

Tel: +86-21-5258-9955

Fax: +86-21-5258-5505

Moxa Europe:

Tel: +49-89-3 70 03 99-0

Fax: +49-89-3 70 03 99-99

Moxa Asia-Pacific:

Tel: +886-2-8919-1230

Fax: +886-2-8919-1231

Moxa India:

Tel: +91-80-4172-9088

Fax: +91-80-4132-1045

MOXA®

© 2016 Moxa Inc. All rights reserved.

P/N: 1802004082010



Overview

The IEX-408E-2VDSL2 is an industrial managed Ethernet extender switch for establishing long distance Ethernet transmissions over twisted-pair copper wiring. IEX-408E-2VDSL2 units can easily be linked in series to form a long distance multi-drop configuration, with one IEX-408E-2VDSL2 unit located at each drop-point. Adjacent drop-points can be separated theoretically by up to 3 km, with a transmission speed of 1 Mbps achieved using a VDSL2 connection (with a connection distance of 300 m, a transmission speed of 100Mbps can be theoretically achieved).

Each IEX-408E-2VDSL2 unit provides six 10/100BaseT(X) and two DSL ports, giving users an incredible amount of flexibility for linking together a wide variety of devices separated by vast distances. With its compact DIN-rail design, the IEX-408E-2VDSL2 series is perfect for use in harsh operating environments with limited installation space.

Redundancy is provided by Turbo Ring, Turbo Chain, RSTP/STP, and MSTP, and a state-of-the-art controllable bypass solution on the DSL ports increases the system reliability and availability of your network.

To simplify configuration, the IEX-408E-2VDSL2 uses CO/CPE automatic negotiation (the factory default setting). The device will automatically adjust CO/CPE status to each DSL connection pair of IEX devices to enable a touch-free of settings.

Package List

The Moxa IEX-408E-2VDSL2 is shipped with the following items. If any of these items are missing or damaged, please contact your customer service representative for assistance.

- 1 IEX-408E-2VDSL2 Extender Switch
- USB Cable: CBL-USBA/B-100
- Protective caps for unused ports
- Documentation and software CD
- Quick installation guide (printed)
- Warranty card

Feature Highlights

- 6 10/100BaseT(X) Fast Ethernet ports and 2 DSL (VDSL2 technology) ports for long distance copper connections (up to 100Mbps @ ~300m and up to 3km @ ~1Mbps over twisted-pair copper wires)
- Automatic CO/CPE negotiation reduces configuration time
- Turbo Ring / Turbo Chain on both Fast Ethernet and DSL ports for fast recovery
- Controllable bypass mode on DSL ports gives higher availability in a daisy chain topology
- Port Trunking on Ethernet and DSL ports for optimum bandwidth utilization
- RADIUS, TACACS+, SNMPv3, IEEE 802.1X, HTTPS, and SSH to enhance network security
- Flexible deployment with 2-pin or RJ11/45 connector on DSL ports
- Easy network management by web browser, Telnet/serial console, Windows utility, ABC-02-USB, and MXview
- Universal power supply options
 - Universal high-voltage (HV) model (IEX-408E-2VDSL2-HV): 110/220 VDC/VAC (88 to 300 VDC, 85 to 264 VAC)
 - Redundant dual inputs low-voltage (LV) model (IEX-408E-2VDSL2-LV): 12/24/48 VDC (9.6 to 60 VDC)

IEX-408E-2VDSL2 Panel Layout

Front Panel View

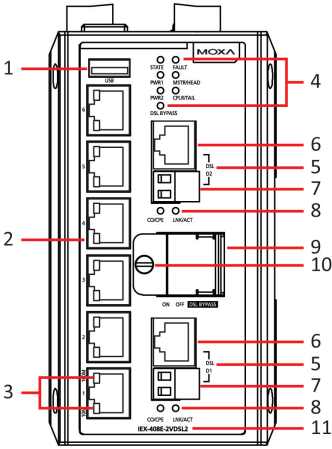

Front Panel:

1. USB storage port (type A connector)
2. 1 to 6: 10/100BaseT(X) port
3. 1 to 6 port status LED
 - Upper LED: 100 Mbps
 - Lower LED: 10 Mbps
4. System status LED:
 - STATE LED indicator
 - PWR1 LED indicator
 - PWR2 LED indicator
 - DSL BYPASS LED indicator
 - FAULT LED indicator
 - MSTR/HEAD LED indicator
 - CPLR/TAIL LED indicator
5. D1 to D2: DSL port
6. DSL port (RJ-45/RJ-11 connector)
7. DSL port (Detachable 2-pin terminal block)
8. D1 to D2 DSL port status LED:
 - CO/CPE LED indicator
 - LNK/ACT LED indicator
9. 3-pin-DIP-switch for controlling DSL Bypass mode
10. Door screw
11. Model name

Top Panel View

IEX-408E-2VDSL2-HV

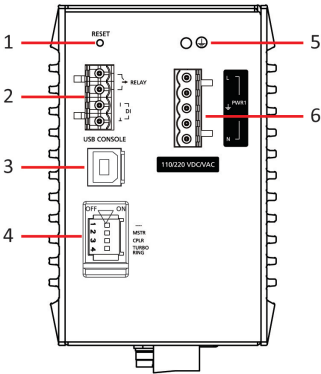

Top Panel:

1. RESET button
2. 4-pin terminal receptor for relay output and digital input
3. USB console port (type B connector)
4. 4-pin-DIP-switch for Turbo Ring, Ring Master, and Ring Coupler
5. Grounding screw (chassis ground)
6. 5-pin terminal receptor for power input(s)
 - Universal high-voltage (HV) model (IEX-408E-2VDSL2-HV): 110/220 VDC/VAC (PWR 1)
 - Redundant dual inputs low-voltage (LV) model (IEX-408E-2VDSL2-LV): 12/24/48 VDC (PWR 1) and 12/24/48 VDC (PWR 2)

IEX-408E-2VDSL2-LV

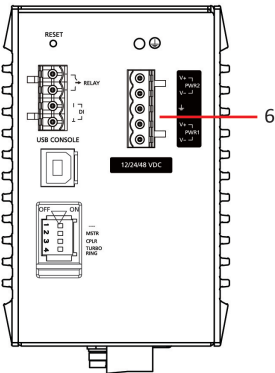

Rear Panel View

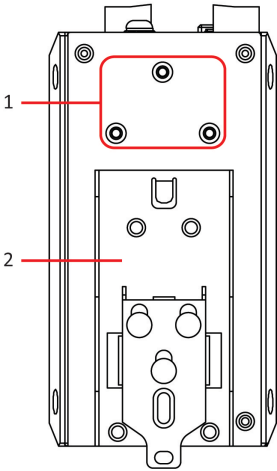

Rear Panel:

1. Screw holes for wall mounting kit
2. DIN-rail mounting kit

Mounting Dimensions - unit = mm (inches)

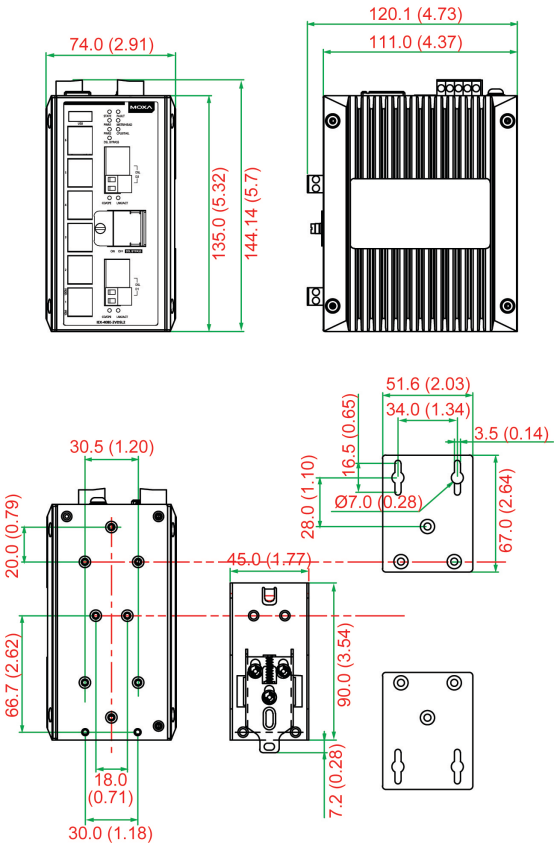

DIN-Rail Mounting

The metal DIN-rail mounting kit is fixed to the back panel of the IEX-408E-2VDSL2. Mount the IEX-408E-2VDSL2 on the corrosion-free mounting rail that meets the EN 60715 standard.

Installation

STEP 1—Insert the upper lip of the DIN-rail kit into the mounting rail.

STEP 2—Press the IEX-408E-2VDSL2 towards the mounting rail until it snaps into place.

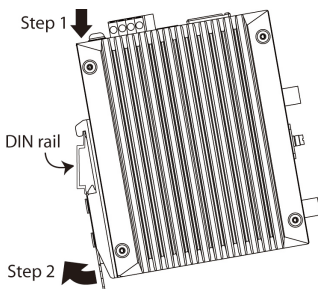

Removal

STEP 1—Pull down the latch on the DIN-rail kit with a screwdriver.

STEP 2 & 3—Slightly pull the IEX-408E-2VDSL2 forward and lift up to remove it from the mounting rail.

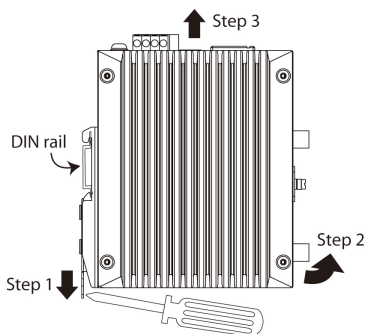

Wall-Mounting (optional)

For some applications, you will find it convenient to mount the Moxa IEX-408E-2VDSL2 on the wall, as shown in the following figures in this section. Please follow below illustrations to install.

STEP 1—Remove the DIN rail attachment plate from the rear panel of the IEX-408E-2VDSL2, and then attach the wall mount plates with M3 screws, as shown in the figure below.

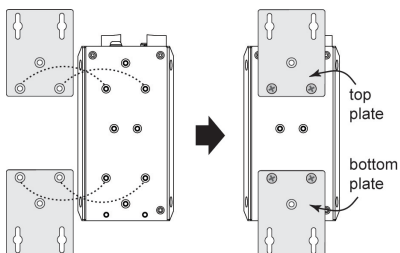

STEP 2—Mounting the IEX-408E-2VDSL2 on the wall requires 4 screws. Use the IEX-408E-2VDSL2, with wall mount plates attached, as a guide to mark the location of the 4 screws. The heads of the screws should be less than 6.0 mm in diameter, and the shafts should be less than 3.5 mm in diameter, as shown in the figure on the right.

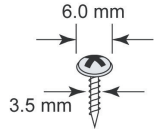

NOTE Before tightening the screws into the wall, make sure the screw head and shank size are suitable by inserting the screw into one of the keyhole-shaped apertures of the wall mounting plates.

STEP 3—Do not tighten the screws completely—leave about 2 mm to allow room for sliding the wall mount panel between the wall and the screws.

STEP 4—Once the screws are fixed into the wall, insert the four screw heads through the large parts of the keyhole-shaped apertures, and then slide the IEX-408E-2VDSL2 downwards, as indicated in the figure on the right. Tighten the four screws for added stability.

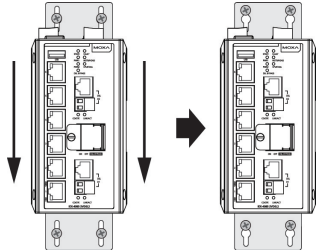

Wiring Requirement



ATTENTION Safety First!

Be sure to disconnect the power cord before installing and/or wiring your Moxa Ethernet Extender Switch. Calculate the maximum possible current in each power wire and common wire. Observe all electrical codes dictating the maximum current allowable for each wire size. If the current goes above the maximum ratings, the wiring could overheat, causing serious damage to your equipment.

Be sure to read and follow these important guidelines:

- Use separate paths to route wiring for power and devices. If power wiring and device wiring paths must cross, make sure the wires are perpendicular at the intersection point.

NOTE Do not run signal or communications wiring and power wiring through the same wire conduit. To avoid interference, wires with different signal characteristics should be routed separately.

- You can use the type of signal transmitted through a wire to determine which wires should be kept separate. The rule of thumb is that wiring that shares similar electrical characteristics can be bundled together.
- You should separate input wiring from output wiring.
- We advise that you label the wiring to all devices in the system.

Grounding the Moxa IEX-408E-2VDSL2 Ethernet

Extender Switch

Grounding and wire routing help limit the effects of noise due to electromagnetic interference (EMI). Run the ground connection from the ground screw (chassis ground) to the grounding surface prior to connecting devices.



ATTENTION

This product is intended to be mounted onto a well-grounded mounting surface, such as a metal panel.



ATTENTION

Before powering on the IEX-408E-2VDSL2, make sure that the grounding cable is secured between the grounding screw (chassis ground) and the ground for surge protection (surge ground) on the 5-pin terminal block for power inputs. Ground for surge protection is on terminal 3 of the terminal block as shown below.

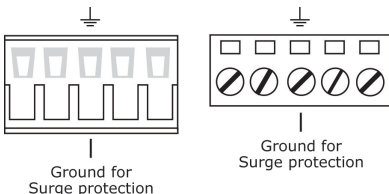

ATTENTION

For dielectric strength (HIPOT) test, users must remove the grounding cable secured between the grounding screw (chassis ground) and ground for surge protection (surge ground) located at terminal 3 of the terminal block to avoid damage.

Wiring the Relay Contact

The IEX-408E-2VDSL2 has one set of relay outputs. These relay output use two contacts of the 4-pin terminal block on the IEX-408E-2VDSL2's top panel.

Refer to the instructions below on how to connect the wires to the terminal block connector, and how to attach the terminal block connector to the terminal block receptor.

STEP 1—Insert the two wires into the RELAY terminals respectively to form an open circuit.

STEP 2—To keep the RELAY wires from coming loose, use a small flathead screwdriver to tighten the wire-clamp screws on the front of the terminal block connector.

STEP 3—Insert the plastic terminal block connector prongs into the terminal block receptor, which is located on the IEX-408E-2VDSL2’s top panel.

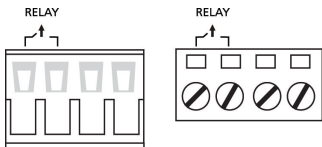

FAULT:

The two contacts of the 4-pin terminal block connector are used to detect user-configured events. The two wires attached to the fault contacts form an open circuit when a user-configured event is triggered. If a user-configured event does not occur, the fault circuit remains closed.

Wiring the Digital Input

The IEX-408E-2VDSL2 has one set of digital input (DI). The DI consists of two contacts of the 4-pin terminal block on the IEX-408E-2VDSL2’s top panel, which are used for the two DC inputs.

Refer to the instructions below on how to connect the wires to the terminal block connector, and how to attach the terminal block connector to the terminal block receptor.

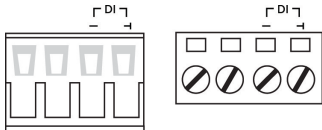

STEP 1: Insert the negative (ground)/positive DI wires into the \perp /I terminals, respectively.

STEP 2: To keep the DI wires from coming loose, use a small flathead screwdriver to tighten the wire-clamp screws on the front of the terminal block connector.

STEP 3: Insert the plastic terminal block connector prongs into the terminal block receptor, which is located on the IEX-408E-2VDSL2’s top panel.

Wiring the Power Input (Universal high-voltage (HV) model: 110/220 VDC/VAC)

The IEX-408E-2VDSL2 HV model (110/220 VDC/VAC) has one set of power inputs (PWR 1)—Pin 1(V+/Line) and Pin5 (V-/Neutral). Insert the 5-pin terminal block connector prongs into the terminal block receptor on IEX-408E-2VDSL2 HV unit properly. The top and front views of the terminal block connector are also shown below.

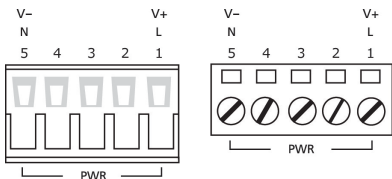

Take the following steps to wire the power input:

STEP 1: Insert the Line/Neutral AC or Positive/Negative DC wires into the terminals (Terminal 1 for Line/Positive and Terminal 5 for Neutral/Negative) of the terminal block connector.

STEP 2: To keep the AC or DC wires from coming loose, use a small flathead screwdriver to tighten the wire-clamp screws on the front of the terminal block connector.

STEP 3: Insert the plastic terminal block connector prongs into the terminal block receptor, which is located on the IEX-408E-2VDSL2 HV unit's top panel.

NOTE The IEX-408E-2VDSL2 HV model (110/220 VDC/VAC) has the reverse protection mechanism for 110/220 VDC input.



ATTENTION

Before connecting the IEX-408E-2VDSL2 HV model to the DC power input, make sure the DC power source voltage is stable.

Wiring the Redundant Power Inputs (low-voltage (LV) model: 12/24/48 VDC)

The IEX-408E-2VDSL2 LV model (12/24/48 VDC) has two sets of power inputs –power input 1 (PWR 1) and power input 2 (PWR 2). Insert the 5-pin terminal block connector prongs into the terminal block receptor on IEX-408E-2VDSL2 LV unit properly. Please take the following steps to wire the redundant power inputs. The top and front views of the terminal block connector are also shown below.

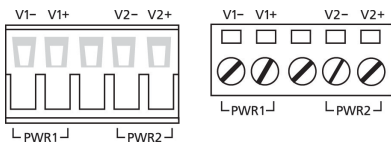

Take the following steps to wire the redundant power inputs:

STEP 1: Insert the Positive/Negative DC wires into the V1+/V1- terminal for PWR 1 and/or V2+/V2- terminal for PWR 2.

STEP 2: To keep the DC wires from coming loose, use a small flathead screwdriver to tighten the wire-clamp screws on the front of the terminal block connector.

STEP 3: Insert the plastic terminal block connector prongs into the terminal block receptor, which is located on the IEX-408E-2VDSL2 LV unit's top panel.



ATTENTION

Before connecting the IEX-40E-2VDSL2 to the DC power inputs, make sure the DC power source voltage is stable.

Communication Connections

Each IEX-408E-2VDSL2 extender switch has 4 types of communication ports:

- 1 USB console port (type B connector)
- 1 USB storage port (type A connector)
- 6 10/100BaseT(X) Fast Ethernet ports
- 2 DSL (VDSL2 technology) ports

USB Console Connection

The IEX-408E-2VDSL2 has one USB console port (type B connector; see below diagram for pinout assignments), located on the top panel. Use the USB cable (provided in the product package) to connect this IEX-408E-2VDSL2's USB console port to your PC's USB port and install the USB driver (available in the software CD) on the PC. You may then use a console terminal program, such as Moxa PComm Terminal Emulator, to access the IEX-408E-2VDSL2's console configuration utility.

USB Console Port (Type B Connector) Pinouts

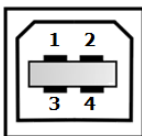

Pin	Description
1	D- (Data -)
2	VCC (+5V)
3	D+ (Data+)
4	GND (Ground)

USB Storage Connection

The IEX-408E-2VDSL2 has one USB storage port (type A connector; see below diagram for pinout assignments) on the front panel. Use Moxa ABC-02-USB-T automatic backup configurator to connect this IEX-408E-2VDSL2's USB storage port for configuration backup, firmware upgrade or system log file backup.

USB Storage Port (Type A Connector) Pinouts

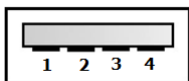

Pin	Description
1	VCC (+5V)
2	D- (Data -)
3	D+ (Data+)
4	GND (Ground)

NOTE ABC-02-USB Installation

Plug the ABC-02-USB into the USB storage port of the Moxa IEX-408E-2VDSL2. Securing the ABC-02-USB on the wall with an M4 screw is suggested.

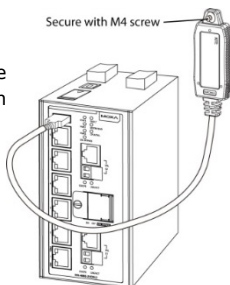

10/100BaseT(X) Ethernet Port Connection

The 10/100BaseT(X) ports located on the IEX's front panel are used to connect to Ethernet-enabled devices. Most users configure these ports for Auto MDI/MDI-X mode, in which case the port's pinouts are adjusted automatically depending on the type of Ethernet cable wiring (straight-through or cross-over), and the type of device (NIC-type or HUB/Switch-type) connected to the port.

Next, we show pinouts for both MDI (NIC-type) ports and MDI-X (HUB/Switch-type) ports, and also show cable wiring diagrams for straight-through and cross-over Ethernet cables.

MDI Port Pinouts

Pin	Signal
1	Tx+
2	Tx-
3	Rx+
6	Rx-

MDI-X Port Pinouts

Pin	Signal
1	Rx+
2	Rx-
3	Tx+
6	Tx-

8-pin RJ45

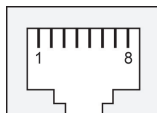

RJ45 (8-pin) to RJ45 (8-pin) Straight-Through Cable Wiring

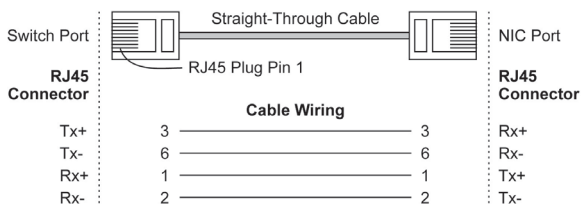

RJ45 (8-pin) to RJ45 (8-pin) Cross-Over Cable Wiring

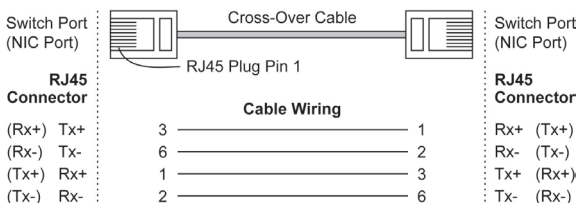

DSL Port Connection

The DSL ports located on the IEX-408E-2VDSL2 has two connection options. One is the RJ45/RJ11 connector interface (2-wire on pin 4 and pin 5; pinouts are illustrated below), the other is the screw detachable 2-pin terminal block interface. Refer to the instructions below on how to connect the wires to the terminal block connector, and how to attach the terminal block connector to the terminal block receptor.

DSL Port Pinouts for RJ45/RJ11 Connector

Pin	Signal
1	-
2	-
3	-
4	Ring
5	Tip
6	-
7	-
8	-

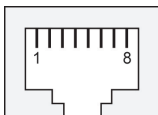

Wiring the 2-pin DSL Port

The 2-pin terminal block connectors on the IEX's front panel are used for the IEX's DSL port wiring. Top and front views of the terminal block connectors are shown below.



Step 1: Insert the wires into the Ring/Tip terminals.

Step 2: To keep the wires from coming loose, use a small flathead screwdriver to tighten the wire-clamp screws on the front of the terminal block connector.

Step 3: Insert the plastic terminal block connector prongs into the terminal block receptor, which is located on the IEX's front panel.

Reset Button

There are two functions available on the reset button. One is to reset the IEX Extender switch back to factory default settings and the other is quick back up configuration and log files to the ABC-02-USB automatic backup configurator.

Reset to Factory Default Settings

Use a pointed object, such as a straightened paper clip or toothpick, to depress and hold the reset button for 5 seconds. This will cause the STATE LED to blink once a second. After depressing the button for 5 continuous seconds, the STATE LED will start to blink rapidly. This indicates that factory default settings have been loaded and you can release the reset button.

NOTE Do NOT power off your Moxa Ethernet extender switch when the default settings are loading.

Configuration and Log Files Back Up

When the ABC-02-USB is connected to the IEX extender switch, the reset button allows quick back up of configuration and log files to the ABC-02-USB. Press the reset button on top of the IEX-408E-2VDSL2, the extender switch will start backing up current system configuration files and event logs to the ABC-02-USB.

DIP Switches Settings

The IEX-408E-2VDSL2 contains 2 DIP switches. One for bypass mode settings and the other for Turbo Ring redundancy settings.

Bypass Mode DIP Switch Settings

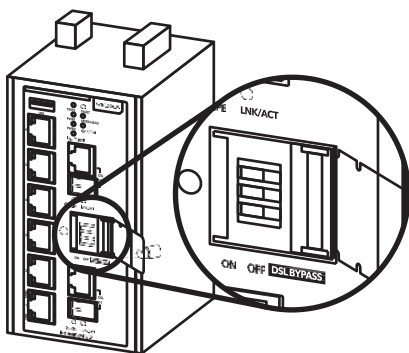

The IEX-408E-2VDSL2 provides a 3-pin-DIP-switch which is located on the front panel for DSL bypass mode configurations. Please open the metal door first in order to adjust the mode and make sure you tighten the screw on the front of the door every time you complete the settings.

Refer to below instructions on how to set the DSL bypass mode.



The default setting for each DIP switch is OFF. When all DIP switches are set to ON positions, as shown in the diagram, it enables bypass mode (you will also see the DSL BYPASS LED light up accordingly). (The DIP switches are in the OFF position when located on the right.) Once the power supply of the IEX-408E-2VDSL2 is off, the bypass function will be triggered and the two separate DSL connections will be linked together accordingly and treated as a new pair/connection.

NOTE Ensure all DIP switches have been set to ON positions in advance in order to enable the bypass mode.

NOTE Ensure you do a proper evaluation and calculation for each pair and pairs with bypass mode enabled in between when enabling bypass mode between DSL ports. Connection may not be able to be established when conditions change, e.g. longer distance.

NOTE Due to the characteristics of DSL technology, the DSL connection needs to be reestablished once it has become disconnected. Therefore, when the bypass function is triggered, you need to wait up to a few minutes for the establishment of the new pair.

Turbo Ring DIP Switch Settings

IEX-408E-2VDSL2 series are plug-and-play managed redundant Ethernet switches. The proprietary Turbo Ring protocol was developed by Moxa to provide better network reliability and faster recovery times. Moxa Turbo Ring's recovery time is less than 300 ms (**Turbo Ring**) or 20 ms on Fast Ethernet ports and 50 ms on DSL ports* (**Turbo Ring V2**)—compared to a 3 to 5 minute recovery time for commercial switches—decreasing the possible loss caused by network failures in an industrial setting.

There is a 4-pin-DIP-switch for Turbo Ring on the top panel of the IEX-408E-2VDSL2 that can help setup the Turbo Ring easily within seconds. If you do not want to use a hardware DIP switch to setup the Turbo Ring, you can use a web browser, telnet, or console to disable this function.

NOTE *50 ms of network recovery only applies when the DSL connection links down from normal.

NOTE Please refer to the **Turbo Ring** section in the **Communication Redundancy** User's Manual for more detailed information about the settings and usage of **Turbo Ring** and **Turbo Ring V2**.

The default setting for each DIP Switch is the OFF position. The following table explains the effect of setting the DIP Switch to the ON position.

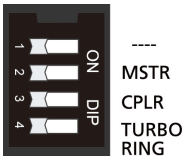

NOTE The default mode when the DIP switch has been activated is set to Turbo Ring V2 protocol. If you want to switch to Turbo Ring protocol, please change the settings via the web browser. The default ring ports are set to the DSL D1/D2 ports with the Ring Coupling or the Primary ports are set to port 5 and the Coupling Control or Backup ports are set to port 6 once you have activated the redundant features through these DIP switches.

“Turbo Ring” DIP Switch Settings

DIP 1	DIP 2	DIP 3	DIP 4
Reserved for future use.	ON: Enables this IEX model as the Ring Master.	ON: Enables the default “Ring Coupling” ports.	ON: Activates DIP switch 2 and 3 to configure “Turbo Ring” settings.
	OFF: This IEX model will not be the Ring Master.	OFF: Do not use this IEX model as the ring coupler.	OFF: DIP switch 1, 2, and 3 will be disabled.

“Turbo Ring V2” DIP Switch Settings

DIP 1	DIP 2	DIP 3	DIP 4
<u>ON</u> : Enables the default “Ring Coupling (backup)” port when DIP switch 3 is already enabled.	<u>ON</u> : Enables this IEX model as the Ring Master.	<u>ON</u> : Enables the default “Ring Coupling” port.	<u>ON</u> : Activates DIP switch 1, 2, and 3 to configure “Turbo Ring V2” settings.
<u>OFF</u> : Enables the default “Ring Coupling (primary)” port when DIP switch 3 is already enabled.	<u>OFF</u> : This IEX model will not be the Ring Master.	<u>OFF</u> : Do not use this IEX model as a ring coupler.	<u>OFF</u> : DIP switch 1, 2, and 3 will be disabled.

NOTE You must enable the Turbo Ring function first before using the DIP switch to activate the Master and Coupler functions.

NOTE If you do not enable any of the IEX-408E-2VDSL2 switches to be the Ring Master, the Turbo Ring protocol will automatically choose the IEX-408E-2VDSL2 with the smallest MAC address range to be the Ring Master. If you accidentally enable more than one IEX-408E-2VDSL2 to be the Ring Master, these IEX-408E-2VDSL2 switches will automatically negotiate to determine which one will be the Ring Master.

CO/CPE automatic negotiation

The VDSL2 connection between 2 units (e.g. 2 IEX-408E-2VDSL2 and connect one DSL port on one IEX from the other DSL port from the other IEX) must operate in pair roles i.e. one port as CO with the other as CPE.

To make configuration easier, the IEX-408E-2VDSL2 supports auto CO/CPE negotiation as the default setting on both DSL ports (DSL D1 and DSL D2). When 2 DSL ports from Moxa’s IEX-408E-2VDSL2 or IEX-402-VDSL2 are connected, auto CO/CPE negotiation will automatically assign one port on one device as the CO and the other port on the other side as the CPE.

Also, by factory default, the 2 DSL ports on one IEX-408E-2VDSL2 are set for one to be CO (DSL D1) and the other to be CPE (DSL D2) with auto CO/CPE negotiation enabled.

NOTE To speed up establishing a DSL connection, we suggest you connect the DSL D1 port on one IEX-408E-2VDSL2 to the DSL D2 port on the other IEX-408E-2VDSL2 when installing.

NOTE The CO/CPE roles on DSL ports can be set/changed through web browser or Telnet/serial console interfaces.

LED Indicators

LED	Color	State	Description
Per Device LED			
PWR 1	Amber	Solid light	Power is being supplied to the main system's power input PWR1
		Light off	Power is not being supplied to the main system's power input PWR1
PWR 2	Amber	Solid light	Power is being supplied to the main system's power input PWR2
		Light off	Power is not being supplied to the main system's power input PWR2
STATE	Green	Solid light	System has passed self-diagnosis test on boot-up and is ready to run
		Blinking	<ol style="list-style-type: none"> System is undergoing the self-diagnosis test System detects ABC-02 USB plugged into USB storage port Blink continuously when pressing the reset button for 5 seconds to reset to factory default Blink twice when pressing the reset button for 2 seconds and release the button for reboot
	Red	Solid light	System failed self-diagnosis on boot-up.
FAULT	Red	Solid light	System is in the event of failure, or is under quick inspection Invalid port connection
		Blinking	<ol style="list-style-type: none"> RAM test fail / switch Init. Fail FW Checksum Fail / Uncompress Fail
		Light off	The system is operating normally
MSTR/ HEAD	Green	Solid light	<ol style="list-style-type: none"> The switch is set as the Master of the Turbo Ring, or as the Head of the Turbo Chain. POST H.W. Fail (+Stat on and Fault blinking).
		Blinking	<ol style="list-style-type: none"> The switch has become the Ring Master of the Turbo Ring. The Head of the Turbo Chain, after the Turbo Ring or the Turbo Chain is down. The switch is set as Turbo Chain's Member and the corresponding chain port is down.
		Light off	<ol style="list-style-type: none"> The switch is not the Master of this Turbo Ring. This switch is set as a Member of the Turbo Chain.

LED	Color	State	Description
Per Device LED			
CPLR/ TAIL	Green	Solid light	<ol style="list-style-type: none"> The switch's coupling function is enabled to form a back-up path. When it's set as the Tail of the Turbo Chain. POST S.W. Fail (+Stat on and Fault blinking)
		Blinking	<ol style="list-style-type: none"> Turbo Chain is down. The switch is set as Turbo Chain's Member and the corresponding chain port is down.
		Light off	<ol style="list-style-type: none"> This switch has disabled the coupling function. This switch is set as a Member of the Turbo Chain.
FAULT + MSTR/HEAD + CPLR/TAIL		Rotate Blinking Sequentially	ABC-02-USB is importing/exporting files
STATE + FAULT + MSTR/HEAD + CPLR/TAIL		Blinking	DSL extender switch is being discovered/located by MXview (2 times/s).
DSL BYPASS	Green	Solid light	The certain device is acting in bypass mode, i.e. the bypass redundant mode is enabled on the DSL ports
		Light off	The certain device is acting in normal mode, i.e. the bypass redundant function is not enabled on the DSL ports
Per DSL Port			
CO/ CPE	Green	Solid light	The port is set as CPE
		Light off	The corresponding port's link is inactive
	Amber	Solid light	The port is set as CO
		Light off	The corresponding port's link is inactive
LINK/ ACT	Green	Solid light	The corresponding port's link is active under STD mode
		Blinking	The corresponding port is auto negotiating for the optimized speed (Blink every 1 sec)
		Light off	The corresponding port's link is inactive
Per 100 Mbps Port LED			
100M	Green	Solid Light	When there is a secure connection (or link) to 100Mbps device at any port.
		Blinking	When there is reception or transmission of data occurring at 100Mbps.
		Light off	Link down or no link
Per 10 Mbps Port LED			
10M	Green	Solid Light	When there is a secure connection (or link) to 10Mbps device at any port.
		Blinking	When there is reception or transmission of data occurring at 10Mbps.
		Off	Link down or no link

Specifications

Technology	
Standards	IEEE 802.3 for 10BaseT IEEE 802.3u for 100BaseT(X) and 100BaseFX IEEE 802.3ab for 1000BaseT(X) IEEE 802.3z for 1000BaseX IEEE 802.3x for Flow Control IEEE 802.1D-2004 for Spanning Tree Protocols IEEE 802.1w for Rapid STP IEEE 802.1Q for VLAN Tagging IEEE 802.1p for Class of Service IEEE 802.1X for Authentication IEEE 802.3ad for Port Trunk with LACP ITU G.993.2 for very high speed digital subscriber line transceivers 2
VDSL2 Data Rate	Up to 100Mbps depends on line condition
Management	SNMP v1/v2c/v3, LLDP, Syslog, RMON, DHCP Server/Client, DHCP Option 66/67/82, BootP, TFTP, SMTP, RARP, Telnet, SNMP Inform, Flow Control, Back Pressure Flow Control
Filter	802.1Q VLAN, Port-Based VLAN, GVRP, IGMP v1/v2/v3, GMRP
Redundancy Protocols	STP, RSTP, MSTP, Turbo Ringv1/v2, Turbo Chain, Link Aggregation
Security	RADIUS, TACACS+, SSL, SSH
Time Management	SNTP, NTP Server/Client
Industrial Protocols	EtherNet/IP, PROFINET IO, Modbus TCP
MIB	MIB-II, Ethernet-Like MIB, P-BRIDGE MIB, Q-BRIDGE MIB, Bridge MIB, RSTP MIB, RMON MIB Group 1, 2, 3, 9
Interface	
RJ45 Ports	10/100BaseT(X) auto negotiation speed, F/H duplex mode, and auto MDI/MDI-X connection
DSL Port	RJ-11(RJ-45 connector) or detachable 2-pin terminal block
USB Ports	USB console port (type B connector); USB storage port (type A connector)
LED Indicators	PWR1, PWR2, FAULT, STATE, MSTR/HEAD, CPLR/TAIL, DSL BYPASS, 10/100M (TP port), CO/CPE (DSL port), LINK/ACT (DSL port)
DIP Switches	Top 4-pin-DIP-switch: TURBO RING, CPLR, MSTR Front 3-pin-DIP-switch: DSL BYPASS
Button	Reset button
Alarm Contact	1 relay output with current carrying capacity of 1 A @ 24 VDC
Digital Input	1 input with the same ground, but electrically isolated from the electronics. <ul style="list-style-type: none"> • +13 to +30V for state "1" • -30 to +3V for state "0" • Max. input current: 8 mA

Power	
Input Voltage	LV Models: 12/24/48 VDC (9.6 to 60 VDC) and -48 VDC, isolated power and redundant dual inputs HV Models: 110/220 VDC/VAC (88 to 300 VDC, 85 to 264 VAC), isolated power
Input Current	Max. 1A @ 12 VDC Max. 0.48A @ 24 VDC Max. 0.26A @ 48 VDC Max. 0.097A/0.050 @ 110/220 VDC Max. 0.230A/0.149 @ 110/220 VAC
Connection	One removable 5-pin terminal block
Overload Current Protection	Present
Reverse Polarity Protection	Present
Physical Characteristics	
Housing	Metal, IP30 protected
Dimension (W x H x D)	74 x 135 x 111 mm (2.91 x 5.32 x 4.37 in)
Weight	LV Models: 1.23 kg / HV Models 1.26 kg
Installation	DIN rail, wall-mount (optional kit)
Environmental Limits	
Operating Temperature	-10 to 60°C (14 to 140°F); -40 to 75°C (-40 to 167°F) for -T models
Storage Temperature	-40 to 85°C (-40 to 185°F)
Ambient Relative Humidity	5% to 95% (non-condensing)
Altitude	Up to 2000 m, please contact Moxa for products guaranteed to function at higher altitudes
Regulatory Approvals	
Safety	UL 61010-2-201
EMC	EN 55022/24
EMI	CISPR 22, FCC Part 15B Class A
EMS	EN 61000-4-2 (ESD): Contact: 8 kV; Air: 15 kV EN 61000-4-3 (RS): 80 MHz to 1 GHz, 10 V/m EN 61000-4-4 (EFT): Power 4 kV EN 61000-4-5 (Surge): Power 4 kV EN 61000-4-6 (CS) 150 kHz to 80 MHz, 10 V/m EN 61000-4-8 (PFMF)
Shock	IEC60068-2-27
Freefall	IEC60068-2-32
Vibration	IEC60068-2-6
Warranty	5 years



ATTENTION

This device complies with Part 15 of the FCC rules.
Operation is subject to the following conditions:

1. This device may not cause harmful interference.
2. This device must accept any interference received including interference that may cause undesired operation.